

» Kontron User's Guide «



SATA II HDD Canister KISS DA 435 Quick Reference Guide

1. Table of Contents

1. Table of Contents	1
2. Important Information	2
3. Safety Precautions	4
4. Product Description	5
4.1. Key features	5
4.2. Checking list.....	5
4.3. Front Panel Features	6
4.3.1. LED indicators	6
4.4. Rear Panel Features	7
4.4.1. Power input connectors	7
4.4.2. Over-Temp. Threshold & Buzzer Setting.....	7
4.4.3. SATA Connectors.....	8
4.4.4. HDD Fail LED Input.....	8
4.4.5. Fan Connectors	8
5. Installation Overview	9
5.1. Removing the HDD Tray from the enclosure	9

2. Important Information

Warranty

Our product is warranted against defects in materials and workmanship for a period of one year from the date of shipment, as evidenced by receipts or other documentation. The manufacture at its option, repair or replace equipment that proves to be defective during the warranty period. This warranty includes parts and labor.

The media on which you receive software are warranted not to fail to execute programming instructions, due to defects in materials and workmanship, for a period of 90 days from date of shipment, as evidenced by receipts or other documentation. The manufacture will, at its option, repair or replace software media that do not execute programming instructions if the manufacture receives notice of such defects during the warranty period. The manufacture does not warrant that the operation of the software shall be uninterrupted or error free.

National Instruments believes that the information in this document is accurate. The document has been carefully reviewed for technical accuracy. In the event that technical or typographical errors exist, the manufacture reserves the right to make changes to subsequent editions of this document without prior notice to holders of this edition. The reader should consult National Instruments if errors are suspected. In no event shall the manufacture be liable for any damages arising out of or related to this document or the information contained in it.

EXCEPT AS SPECIFIED HEREIN, THE MANUFACTURER MAKES NO WARRANTIES, EXPRESS, IMPLIED, OR STATUTORY AND DISCLAIMS ANY IMPLIED WARRANTY OR CONDITION OF MERCHANTABILITY, FITNESS FOR A PARTICULAR PURPOSE, OR NON-INFRINGEMENT, OR A WARRANTY THAT THE PRODUCT WILL OPERATE ERROR FREE.

IN NO EVENT SHALL THE MANUFACTURER BE LIABLE FOR THE COST OF PROCUREMENT OF SUBSTITUTE HARDWARE, SOFTWARE, OR SERVICES, LOST PROFITS, LOST DATA, OR ANY SPECIAL, INDIRECT, CONSEQUENTIAL, OR INCIDENTAL DAMAGES, HOWEVER CAUSED AND ON ANY THEORY OF LIABILITY ARISING IN ANY WAY OUT OF THIS AGREEMENT OR THE SERVER. THIS LIMITATION SHALL APPLY EVEN IF THE MANUFACTURER HAS BEEN ADVISED OF THE POSSIBILITY OF SUCH DAMAGES, AND NOTWITHSTANDING ANY FAILURE OF ESSENTIAL PURPOSE OF ANY LIMITED REMEDY PROVIDED HEREIN.

This limitation of the liability of the manufacturer will apply regardless of the form of action, whether in contract or tort, including negligence. Any action against the manufacturer must be brought within one year after the cause of action accrues. The manufacture shall not be liable for any delay in performance due to causes beyond its reasonable control. The warranty provided herein does not cover damages, defects, malfunctions, or service failures caused by owner's failure to follow the manufacture installation, operation, or maintenance instructions; owner's modification of the product; owner's abuse, misuse, or negligent acts; and power failure or surges, fire, flood, accident, actions of third parties, or other events outside reasonable control.

Copyright

Under the copyright laws, this publication may not be reproduced or transmitted in any form, electronic or mechanical, including photocopying, recording, storing in an information retrieval system, or translating, in whole or in part, without the prior written consent of the manufacture.

Trademarks

Product and company names mentioned herein are trademarks or trade names of their respective companies.

Changes

The Manufacturer reserves the right to revise this publication and to make changes in the content hereof without the obligation of the manufacturer to notify any person of such revision or changes.

3. Safety Precautions

Before getting started, please read the following important cautions:

- All cautions and warnings on the equipment or in the manuals should be noted.
- Most electronic components are sensitive to electrical static discharge. Therefore, be sure to ground yourself at all times when installing the internal components. Use a grounding wrist strap and place all electronic components in static-shielded devices. Grounding wrist straps can be purchased in many electronic supply stores.
- Do not open the top cover of the system. If opening the cover for maintenance is a must, only a trained technician should do so. Integrated circuits on computer boards are sensitive to static electricity. Before handling a board or integrated circuit, touch an unpainted portion of the system unit chassis for a few seconds. This will help to discharge any static electricity on your body.
- Place this equipment on a reliable surface when install. A drop or fall could cause injury.
- Please keep this equipment away from humidity.
- Do not leave this equipment in an environment unconditioned, out of operation or storage temperature range may damage the equipment.
- Never pour any liquid into ventilation openings, this could cause fire or electrical shock.
- Make sure the voltage of the power source is within the specification on the label when connecting the equipment to the power outlet. The current load and output power of loads shall be within the specification.
- This equipment must be connected to reliable grounding before using.
- Place the power cord out of the way of foot traffic. Do not place anything over the power cord. The power cord must be rated for the product, voltage and current marked on the product's electrical rating label. The voltage and current rating of power cord should be greater than the voltage and current rating marked on the product.
- If the equipment is not used for a long time, disconnect the equipment from mains to avoid being damaged by transient over-voltage.
- Never open the equipment. For safety concerns, only qualified service personnel should open the equipment for maintenance.
- If one of the following situations arise, the equipment should be checked by service personnel:
 - ✓ The power cord or plug is damaged.
 - ✓ Liquid has penetrated the equipment.
 - ✓ The equipment has been exposed to moisture.
 - ✓ The equipment does not work well or will not work according to its user manual.
 - ✓ The equipment has been dropped and/or damaged.
 - ✓ The equipment has obvious signs of breakage.
 - ✓ Please disconnect this equipment from the AC outlet before cleaning. Do not use liquid or detergent for cleaning. The use of a moisture sheet or cloth is recommended for cleaning.

Note: Product features and specifications are subject to change without notice.

4. Product Description

4.1. Key features

- Support four 3.5" SAS and/or SATA II hard disk drives (HDD) on 3 ODD Bays space.
- Support direct HDD Fault LEDs signal input (from HBA Card)
- Support HDD activity LEDs directly from SAS/SATA II HDD
- Enclosure Over-Temperature Alarm (Buzzer and LED).
- Adjustable Over-Temperature Threshold Setting.
- Fan Speed Control.

4.2. Checking list

Before removing the subsystem from the shipping carton, visually inspect the physical condition of the shipping carton. Exterior damage to the shipping carton may indicate that the contents of the carton are damaged. If any damage is found, do not remove the components; contact to the dealer where the subsystem was purchased for further instructions. Before continuing, first unpack the subsystem and verify that the contents of the shipping carton are all there and in good condition.

The package contains the following items:

- One set with HDD tray: x4 (Shipping without drive devices installed)
- Mounting screws: x1 set
- Jumper: x2

Note: Inspect the shipping cartons for evidence of physical damage. If a shipping carton appears damaged, request that the carrier's agent be present when the carton is opened. Keep all contents and packing materials for the agent's inspection.

4.3. Front Panel Features

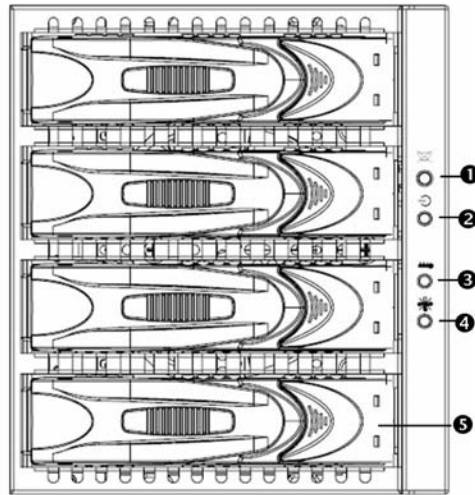



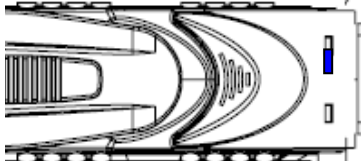
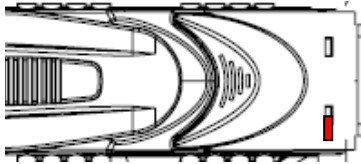

Fig. 1: front view of 3 to 4 canister

❶ Buzzer mute	❷ Power LED	❸ Over Temperature LED
❹ Fan Fail LED	❺ Drive tray	

4.3.1. LED indicators

LED NAME	Color definition	Behavior
 Power LED	Blue	On: when system is powered on Off: when system is powered off
 Over Temperature LED	Red	On: when system temperature exceeds threshold temperature Off: when system temperature is normal.
 Fan fail LED	Red	On: when system detected fan abnormality Off: when fan is normal operation
	HDD Activity/Ready: Blue color	On: when HDD is inserted and detected. Flash: when accessing HDD Off: when there is no HDD or no detection.
	HDD Failure: Red color	On: when HDD is detected as failure by host Flash: RAID rebuilding Off: when there is no HDD or normal (only supported on HBA)

4.4. Rear Panel Features

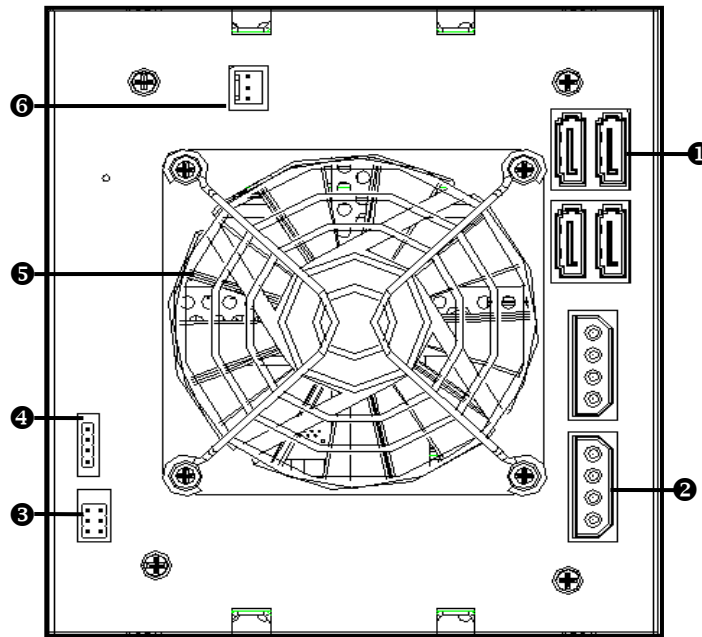

Fig. 2: rear view of 3 to 4 canister

❶ SATA connector	❷ Power input connectors
❸ Over-Temp Threshold & Buzzer Setting	❹ HDD Fail LED Input
❺ Fan	❻ Fan connector

4.4.1. Power input connectors



Four-pin standard power connectors for +12V/+5V/GND

4.4.2. Over-Temp. Threshold & Buzzer Setting

Setting for "Over-Temp." alarm threshold.

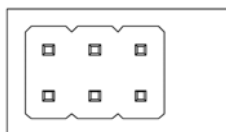

50°C	45°C	MUTE
------	------	------

Pin Number	Description
1-2	50°C
3-4	45°C
5-6	Buzzer-Disable*

Note*: If you want to enable Buzzer alarm on Fan and Temperature Failure, this jumper has to be opened.

4.4.3. SATA Connectors

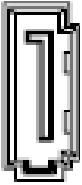

Standard 7Pin SATA connector to link to MB or HBA card.

4.4.4. HDD Fail LED Input

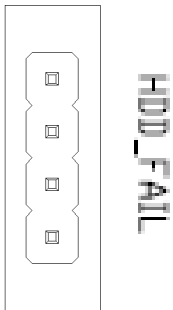

Pin Number	Description
1	HDD 0 Fail Input
2	HDD 1 Fail Input
3	HDD 2 Fail Input
4	HDD 3 Fail Input

For some HBA supporting HDD Fail signal output. If used, this connector should be connected with HDD Fault signal from HBA by external cable.

It's left to open, as default, when HBA doesn't support it.

4.4.5. Fan Connectors

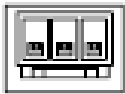

Pin Number	Description
1	GND
2	+12V
3	Tach

A 3-pin fan connector with failure detection

5. Installation Overview

Warning

Before you remove or install the unit, make sure the unit is not turned on or connected to the AC power.

5.1. Removing the HDD Tray from the enclosure

1. Press the latch to the right by the thumb.
2. Pull the tray door outward by the forefinger at the same time.



3. Pull the HDD tray from the bay gently.
4. Secure the HDD to the tray by using four mounting screws shown as below.

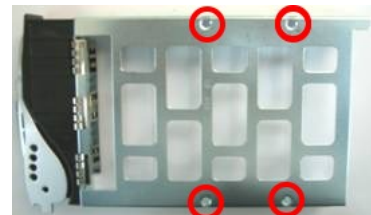
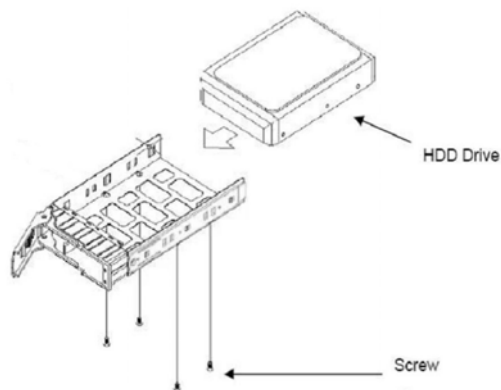

Fig. 3: Bottom view of HDD tray

5. Slide the HDD tray into drive slot until the handle is locked.



6. Repeat step 1 to 5 for all remaining HDD trays.