

» Kontron User's Guide «

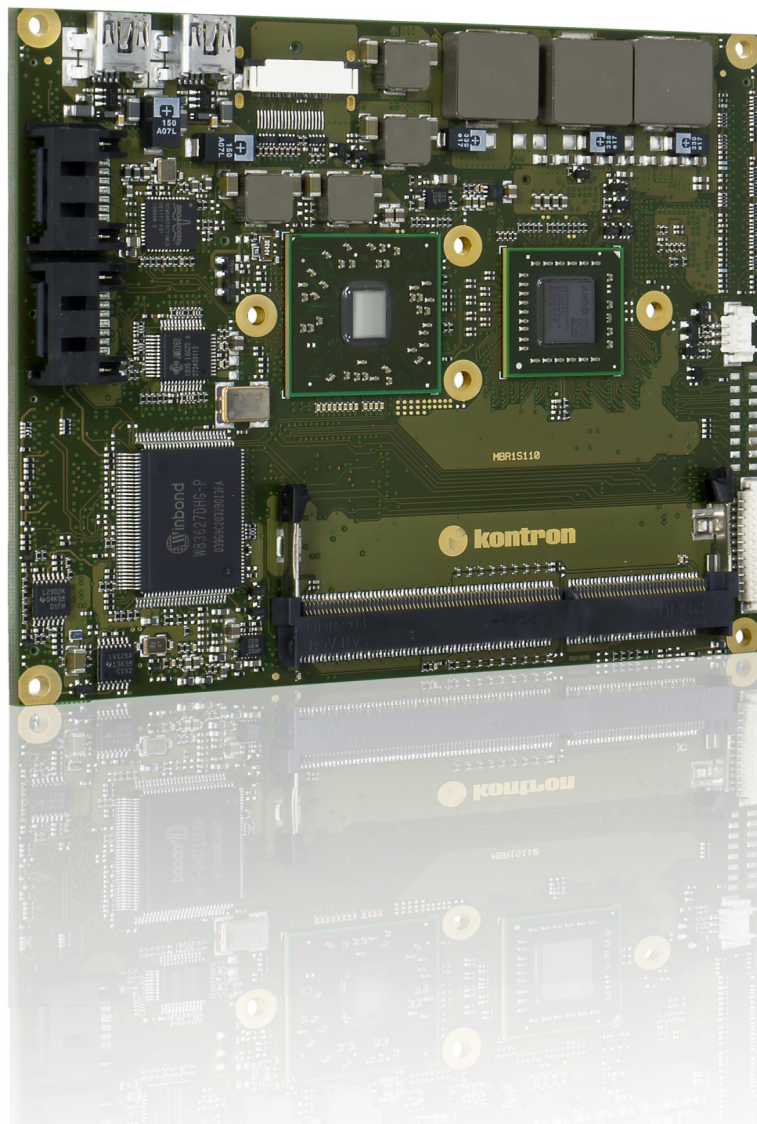

ETX-OH

Document Revision 140

» Table of Contents «

1	<u>User Information</u>	5
1.1	<u>About This Document</u>	5
1.2	<u>Copyright Notice</u>	5
1.3	<u>Trademarks</u>	5
1.4	<u>Standards</u>	5
1.5	<u>Warranty</u>	6
1.6	<u>Technical Support</u>	6
2	<u>Introduction</u>	7
2.1	<u>Product Description</u>	7
2.2	<u>ETX® Documentation</u>	7
2.3	<u>ETX® Benefits</u>	7
3	<u>Specification</u>	8
3.1	<u>Modules & Accessories</u>	8
3.2	<u>Functional Specification</u>	9
3.3	<u>Block Diagram</u>	12
3.4	<u>Electrical Specification</u>	13
3.4.1	<u>Supply Voltage</u>	13
3.4.2	<u>Power Supply Rise Time</u>	13
3.4.3	<u>Supply Voltage Ripple</u>	13
3.4.4	<u>Power Consumption</u>	13
3.5	<u>Environmental Specification</u>	14
3.5.1	<u>Temperature Specification</u>	14
3.5.2	<u>Humidity</u>	14
3.6	<u>Standards and Certifications</u>	15
3.7	<u>MTBF</u>	17
3.8	<u>Mechanical Specification</u>	18
3.9	<u>Module Dimensions</u>	18
3.10	<u>Thermal Management, Heatspreader and Cooling Solutions</u>	19
3.11	<u>Onboard Connectors</u>	20
3.11.1	<u>FAN</u>	20
3.11.2	<u>SATA</u>	21
3.11.3	<u>USB</u>	21
3.11.4	<u>DisplayPort</u>	21
3.11.5	<u>CPU Debug & CPLD</u>	21
4	<u>Features and Interfaces</u>	22
4.1	<u>Onboard SSD</u>	22
4.2	<u>S5 Eco Mode</u>	23
4.3	<u>M.A.R.S.</u>	24
4.4	<u>Fast I2C</u>	25
4.5	<u>EAPI, JIDA & PLD Driver</u>	26

4.6	K-Tools	27
4.7	K-Station 2 GUI	27
4.8	KeAPI	28
4.9	Watchdog Timer	29
4.10	C-States	30
4.11	ACPI Suspend Modes and Resume Events	31
5	System Resources.....	32
5.1	Interrupt Request (IRQ) Lines	32
5.2	Memory Area	32
5.3	I/O Address Map	33
6	ETX® Connectors.....	34
6.1	General Signal Description	34
6.2	Connector X1 (PCI bus, USB, Audio)	35
6.2.1	Connector X1 Signal Levels	36
6.3	Connector X2 (ISA Bus)	38
6.3.1	Connector X2 Signal Levels	39
6.3.2	Connector X3 (Signal Levels)	41
6.4	Connector X4 Subsystems	43
6.4.1	Connector X4 (IDE 1, IDE 2, Ethernet, Miscellaneous)	43
6.4.2	Connector X4 (Signal Levels)	44
7	BIOS Operation.....	46
7.1	Determining the BIOS Version	46
7.2	BIOS Update	46
7.3	Setup Guide	48
7.4	POST Codes	48
7.4.1	Start AMI® Aptio Setup Utility	48
7.5	BIOS Setup	49
7.5.1	Main	49
7.5.2	Advanced	51
7.5.3	Chipset	83
7.5.4	Boot	93
7.5.5	Security	98
7.5.6	Save & Exit	99

1 User Information

1.1 About This Document

This document provides information about products from Kontron Europe GmbH and/or its subsidiaries. No warranty of suitability, purpose, or fitness is implied. While every attempt has been made to ensure that the information in this document is accurate, the information contained within is supplied "as-is" and is subject to change without notice.

For the circuits, descriptions and tables indicated, Kontron assumes no responsibility as far as patents or other rights of third parties are concerned.

1.2 Copyright Notice

Copyright © 2003-2014 Kontron Europe GmbH

All rights reserved. No part of this document may be reproduced, transmitted, transcribed, stored in a retrieval system, or translated into any language or computer language, in any form or by any means (electronic, mechanical, photocopying, recording, or otherwise), without the express written permission of Kontron Europe GmbH.

DIMM-PC®, PISA®, ETX®, ETXexpress®, microETXexpress®, X-board®, DIMM-IO® and DIMM-BUS® are trademarks or registered trademarks of Kontron Europe GmbH. Kontron is trademark or registered trademark of Kontron AG.

1.3 Trademarks

The following lists the trademarks of components used in this board.

- » IBM, XT, AT, PS/2 and Personal System/2 are trademarks of International Business Machines Corp.
- » Microsoft is a registered trademark of Microsoft Corp.
- » Intel is a registered trademark of Intel Corp.
- » All other products and trademarks mentioned in this manual are trademarks of their respective owners.

1.4 Standards

Kontron Europe GmbH is certified to ISO 9000 standards.

1.5 Warranty

For this Kontron Europe GmbH product warranty for defects in material and workmanship exists as long as the warranty period, beginning with the date of shipment, lasts. During the warranty period, Kontron Europe GmbH will decide on its discretion if defective products are to be repaired or replaced.

Within the warranty period, the repair of products is free of charge as long as warranty conditions are observed.

Warranty does not apply for defects arising/resulting from improper or inadequate maintenance or handling by the buyer, unauthorized modification or misuse, as well as the operation outside of the product's environmental specifications and improper installation and maintenance.

Kontron Europe GmbH will not be responsible for any defects or damages to other products not supplied by Kontron Europe GmbH that are caused by a faulty Kontron Europe GmbH product.

1.6 Technical Support

Technicians and engineers from Kontron Europe GmbH and/or its subsidiaries are available for technical support. We are committed to make our product easy to use and will help you use our products in your systems.

Please consult our Website at <http://www.kontron.com/support> for the latest product documentation, utilities, drivers and support contacts. Consult our customer section <http://emdcustomersection.kontron.com> for the latest BIOS downloads, Product Change Notifications, Board Support Packages, DemoImages, 3D drawings and additional tools and software. In any case you can always contact your board supplier for technical support.

2 Introduction

2.1 Product Description

Kontron's ETX®-OH extends availability and reliability of the established form factor ETX®. It is a successor product for existing ETX® designs. ETX®-OH raises your investment protection for your ETX® designs.

This Computer-on-Module is populated with AMD's Fusion technology and brings new graphic performance for userfriendly interfaces or HD video onto your designs.

2.2 ETX® Documentation

This product manual serves as one of three principal references for an ETX® design. It documents the specifications and features of ETX®-CD. The other two references, which are available from the Kontron Europe GmbH Web site, include:

- » The ETX® Specification defines the ETX® module form factor, pinout, and signals.
- » The ETX® Design Guide serves as a general guide for baseboard design, with a focus on maximum flexibility to accommodate a wide range of ETX® modules.



Some of the information contained within this product manual applies only to certain product revisions (CE: xxx). If certain information applies to specific product revisions (CE: xxx) it will be stated. Please check the product revision of your module to see if this information is applicable.

2.3 ETX® Benefits

Embedded technology extended (ETX) modules are very compact (114 x 95 mm), highly integrated computers. All ETX® modules feature a standardized form factor and a standardized connector layout that carry a specified set of signals. This standardization allows designers to create a single-system baseboard that can accept present and future ETX® modules. ETX® modules include common personal computer (PC) peripheral functions such as:

- » Graphics
- » Parallel, Serial, and USB ports
- » Keyboard/mouse
- » Ethernet
- » Sound
- » IDE (and SATA)

The baseboard designer can optimize exactly how each of these functions implements physically. Designers can place connectors precisely where needed for the application on a baseboard designed to optimally fit a system's packaging. Peripheral PCI or ISA buses can be implemented directly on the baseboard rather than on mechanically unwieldy expansion cards. The ability to build a system on a single baseboard using the computer as one plug-in component simplifies packaging, eliminates cabling, and significantly reduces system-level cost. A single baseboard design can use a range of ETX® modules. This flexibility can differentiate products at various price/performance points, or to design future proof systems that have a builtin upgrade path. The modularity of an ETX® solution also ensures against obsolescence as computer technology evolves. A properly designed ETX® baseboard can work with several successive generations of ETX® modules. An ETX® baseboard design has many advantages of a custom, computer-board design but delivers better obsolescence protection, greatly reduced engineering effort, and faster time to market.

3 Specification

3.1 Modules & Accessories

The Computer-on-Module ETX®-OH (MBR1) based on AMD's Brazos platform is available in different variants to cover the demand of different performance, price and power:

Commercial grade modules (0°C to 60°C operating)

Product Number	Product Name	Processor	Chipset and Features
18040-0000-16-2	ETX-OH T56N	AMD G-Series T56N 2×1.65GHz	AMD A55E FCH
18040-0000-16-4	ETX-OH T56E	AMD G-Series T56E 2×1.65GHz	AMD A55E FCH
18040-0000-10-2	ETX-OH T40E	AMD G-Series T40E 2×1.0GHz	AMD A55E FCH
18040-0000-15-1	ETX-OH T52R	AMD G-Series T52R 1.5GHz	AMD A55E FCH
18040-0000-10-1	ETX-OH T40R	AMD G-Series T40R 1.0GHz	AMD A55E FCH
18040-0000-06-1	ETX-OH T16R	AMD G-Series T16R 615MHz	AMD A55E FCH

Extended temperature modules (E1, -25°C to 75°C operating)

Product Number	Product Name	Processor	Chipset and Features
18040-0000-16-2EXT	ETX-OH T56N E1	AMD G-Series T56N 2×1.65GHz	AMD A55E FCH, E1
18040-0000-16-4EXT	ETX-OH T56E E1	AMD G-Series T56E 2×1.65GHz	AMD A55E FCH, E1
18040-0000-10-2EXT	ETX-OH T40E E1	AMD G-Series T40E 2×1.0GHz	AMD A55E FCH, E1
18040-0000-10-1EXT	ETX-OH T40R E1	AMD G-Series T40R 1.0GHz	AMD A55E FCH, E1
18040-0000-06-1EXT	ETX-OH T16R E1	AMD G-Series T16R 615MHz	AMD A55E FCH, E1

Optional hardware features:

- » TPM
- » DP connector instead of FlatFoil
- » Onboard SATA NANDrive
- » Onboard miniUSB connector

Accessories

Product Number	Carrier Boards
18010-0000-00-0	ETX® Eval
18028-0000-00-0	ETX® miniBaseboard
Product Number	Memory
97015-1024-16-0	DDR3-1600 SODIMM 1GB
97015-2048-16-0	DDR3-1600 SODIMM 2GB
97015-4096-16-0	DDR3-1600 SODIMM 4GB
97015-1024-16-2	DDR3-1600 SODIMM 1GB E2
97015-2048-16-2	DDR3-1600 SODIMM 2GB E2
97015-4096-16-2	DDR3-1600 SODIMM 4GB E2
Product Number	Cooling & Mounting
18040-0000-99-0	ETX®-OH, Heatspreader, threaded
18040-0000-99-1	ETX®-OH, Heatspreader, through hole
18099-0000-99-0	ETX® Active Uni Cooler (5V FAN)
36099-0000-99-0	COMe Active Uni Cooler (12V FAN)
36099-0000-99-1	COMe Passive Uni Cooler
Product Number	Adapter & Cables
96085-0000-00-0	KAB-ADAPT-FF-DP (22pin Flatfoil to DisplayPort adapter cable)
96006-0000-00-8	ADA-DP-LVDS (DP to LVDS converter)
9-5000-0352	ADA-LVDS-DVI 18bit (LVDS to DVI converter)
9-5000-0353	ADA-LVDS-DVI 24bit (LVDS to DVI converter)
96082-0000-00-0	KAB-ADAPT-DP-DVI (DP to DVI adapter cable)
96083-0000-00-0	KAB-ADAPT-DP-VGA (DP to VGA adapter cable)
96084-0000-00-0	KAB-ADAPT-DP-HDMI (DP to HDMI adapter cable)
96079-0000-00-0	KAB-HSP 200mm (Cable adapter to connect FAN to module)
96079-0000-00-2	KAB-HSP 40mm (Cable adapter to connect FAN to module)

3.2 Functional Specification

Processor

The 40nm AMD™ embedded G-Series APU Rev C0 (eOntario) with FT1 (413-BGA) Package CPU supports:

- » AMD64
- » AMD PowerNow!
- » DMX: AMD Digital Media Xpress™ technology (SSE, SSE2, SSE3, SSE4a, MMX instructions)
- » AMD-V™: AMD Virtualization™ technology
- » EVP: AMD Enhanced Virus Protection

Processor	Cores	Clock	L2 Cache	Memory	GPU Core	GPU Clock (Turbo)	AMD Turbo Core	Max TDP
AMD G-Series T56N	2	1.65GHz	2x512kB	DDR3-1333	Radeon HD6320	500MHz (600MHz)	Yes	18W
AMD G-Series T56E	2	1.65GHz	2x512kB	DDR3-1333	Radeon HD6250	280MHz	No	18W
AMD G-Series T40E	2	1.00GHz	2x512kB	DDR3-1066	Radeon HD6250	280MHz	No	6.4W
AMD G-Series T52R	1	1.50GHz	512kB	DDR3-1333	Radeon HD6310	500MHz	No	18W
AMD G-Series T40R	1	1.00GHz	512kB	DDR3-1066	Radeon HD6250	280MHz	No	5.5W
AMD G-Series T16R	1	615MHz	512kB	DDR3-1066	Radeon HD6250	280MHz	No	4.5W

Memory

Sockets	1x DDR3 SO-DIMM
Memory Type	DDR3-1066/1333
Maximum Size	4GB
Technology	Single Channel

Graphics Core

The integrated Mobility Radeon HD6320/6310/6250 supports:

- » UVD: Unified Video Decoder for hardware decode of high definition video
- » 80 Stream Processing Units (SPs)
- » 8 Texture Mapping Units (TMUs)
- » 4 Raster Operation Processors (ROPs)

Graphics Core Render Clock	HD6320/10: 500MHz (T56N, T52R), HD6250: 280MHz (T40E, T40R, T16R)
Execution Units / Pixel Pipelines	4 with 80 unified shader
Max Graphics Memory	512MB
GFX Memory Bandwidth (GB/s)	17.1
GFX Memory Technology	UMA
API (DirectX/OpenGL)	11 / 4.1 + OCL 1.1
Shader Model	5.0
Hardware accelerated Video	ATI Avivo HD: H.264, VC-1, Blu-ray
Independent/Simultaneous Displays	2

Display Interfaces

CRT max Resolution	2560x1600 / 1920x1200
TV out:	-
Digital Display:	DP++ (FFC22 or optional DP connector)

LVDS

LVDS Bits/Pixel	1x18, 2x18, 1x24, 2x24
LVDS Bits/Pixel with dithering	-
LVDS max Resolution:	1920x1200
PWM Backlight Control:	YES

Chipset & IOH

# of USB:	4x USB 1.1/2.0
USB onboard Connector:	2x miniUSB optional
Audio:	Realtek ALC886GR HDAudio
PCI Bus:	PCI Rev 2.3 (33MHz/3.3V)
ISA Bus:	PCI2ISA ITE8888
SuperI/O Controller	Winbond 83627DHG-P
COM Ports:	2x RS232
IrDA Support:	IrDA 1.0 (SIR) or ASK-IrDA (COM2)
LPT Support:	EPP, ECP, bi-dir.
Max TDP:	4.7W

Storage

Primary IDE:	JMB368 PCIe2PATA
Secondary IDE:	JMB368 PCIe2PATA
SATA onboard connector:	2x SATA 3Gb/s
SATA features:	Raid0/1, NCQ, HotPlug, eSATA
SATA RAID support:	-
onboard SSD:	2-32GB SLC or 2-64GB MLC optional
onboard CF Card:	-

Onboard devices

Audio	Realtek ALC886GR HDAudio
Trusted Platform Module	Infineon TPM 1.2 SLB9635TT optional

Ethernet

The Broadcom BCM54610 ethernet supports:

- » Jumbo Frames
- » Time Sync Protocol Indicator
- » WOL (Wake On LAN), WoL from S5 not supported
- » PXE (Preboot eXecution Environment)

Kontron Features

I2C/SMB support:	YES/YES
M.A.R.S. support	YES
Embedded API	PICMG EAPI / JIDA32
Custom BIOS Settings / Flash Backup	YES
Watchdog support	YES

Power Features

ACPI	ACPI 3.0
S-States	S0, S3, S4, S5
Graphic States	D0,D3
Misc Power Management	DPST 6.0

Power Consumption and Performance

Full Load Power Consumption	9 - 19.4W
Kontron Performance Index	5920 - 15443
Kontron Performance/Watt	661 - 997



Detailed Power Consumption measurements in all states and benchmarks for CPU, Graphics and Memory performance are available in Application Note [KEMAP054](#) at [EMD Customer Section](#).

Supported Operating Systems

The ETX®-OH supports:

- » Microsoft Windows CE6
- » Microsoft Windows embedded Compact 7 (WEC7)
- » Microsoft Windows embedded Standard 7 (WES7)
- » Microsoft Windows XP
- » Microsoft Windows 7
- » Linux
- » VxWorks

3.3 Block Diagram

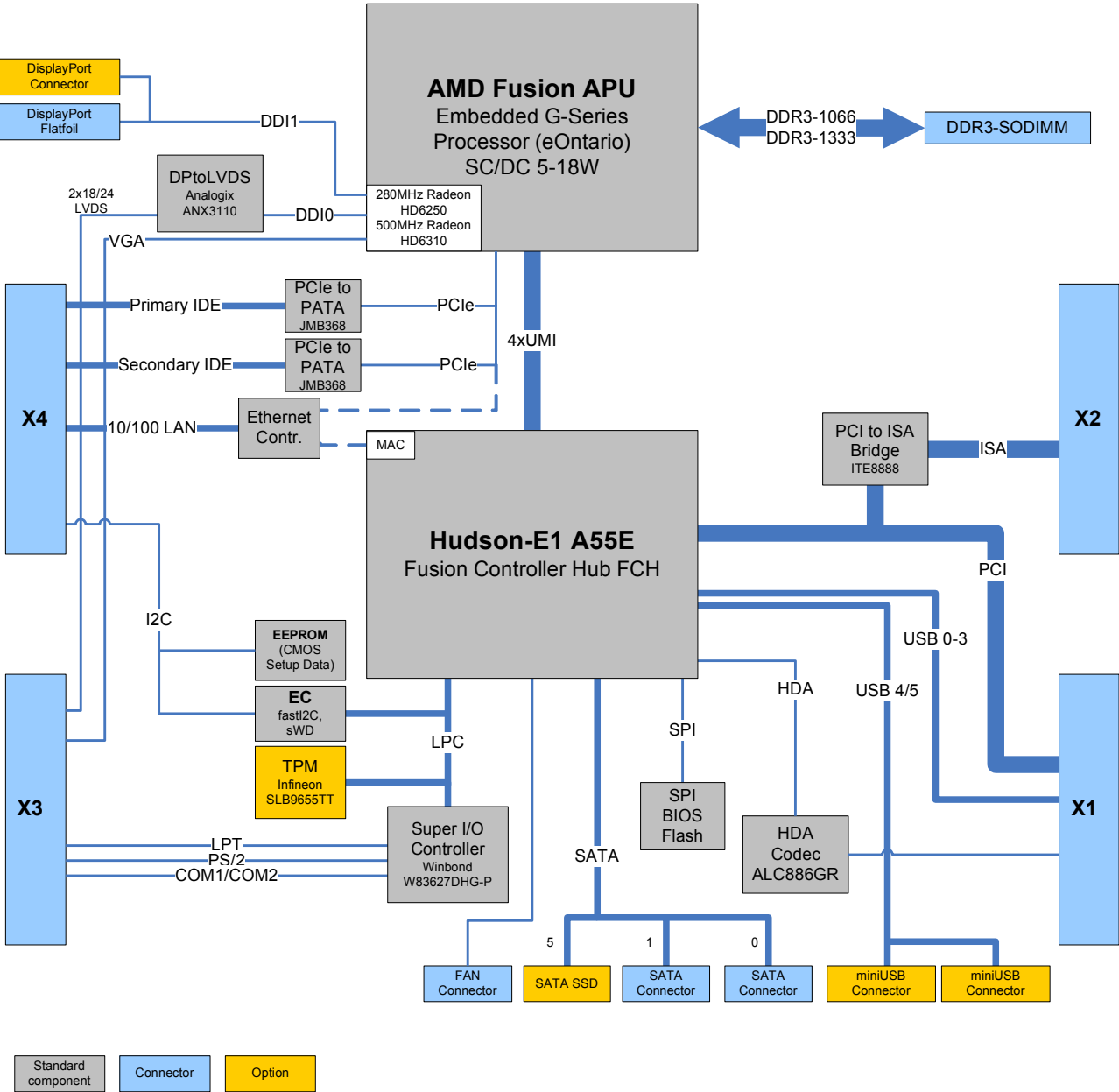

3.4 Electrical Specification

3.4.1 Supply Voltage

Following supply voltage is specified at the ETX® connector:

Supply Voltage:	5V +/- 5%
5V_Stb:	5V DC +/- 5%

3.4.2 Power Supply Rise Time

- » The input voltages shall rise from $\leq 10\%$ of nominal to within the regulation ranges within 0.1ms to 20ms.
- » There must be a smooth and continuous ramp of each DC input voltage from 10% to 90% of its final set-point following the ATX specification

3.4.3 Supply Voltage Ripple

- » Maximum 100 mV peak to peak 0 – 20 MHz

3.4.4 Power Consumption

The maximum Power Consumption of the different ETX®-OH modules is 9 - 19.4W (100% CPU load; 90°C CPU temperature). Further details with measurements and TDP values of the single variants can be found in our [customer section](#). Information there is available after registration.

3.5 Environmental Specification

3.5.1 Temperature Specification

Kontron defines following temperature grades for Computer-on-Modules in general. Please see chapter 'Product Specification' for available temperature grades for the ETX@-OH

Temperature Specification	Operating	Non-operating	Validated Input Voltage
Commercial grade	0°C to +60°C	-30°C to +85°C	VCC:
Extended Temperature (E1)	-25°C to +75°C	-30°C to +85°C	VCC: 12V
Industrial grade by Screening (XT)	-40°C to +85°C	-40°C to +85°C	VCC: 12V
Industrial grade by Design (E2)	-40°C to +85°C	-40°C to +85°C	VCC:

Operating with Kontron heatspreader plate assembly

The operating temperature defines two requirements:

- » the maximum ambient temperature with ambient being the air surrounding the module.
- » the maximum measurable temperature on any spot on the heatspreader's surface

Test specification:

Temperature Grade	Validation requirements
Commercial grade	at 60°C HSP temperature the CPU @ 100% load needs to run at nominal frequency
Extended Temperature (E1)	at 75°C HSP temperature the CPU @ 75% load is allowed to start speedstepping for thermal protection
Industrial grade by Screening (XT)	at 85°C HSP temperature the CPU @ 50% load is allowed to start throttling for thermal protection
Industrial grade by Design (E2)	at 85°C HSP temperature the CPU @ 50% load is allowed to start throttling for thermal protection

Operating without Kontron heatspreader plate assembly

The operating temperature is the maximum measurable temperature on any spot on the module's surface.

3.5.2 Humidity

- » 93% relative Humidity at 40°C, non-condensing (according to IEC 60068-2-78)

3.6 Standards and Certifications

RoHS II

The **ETX®-OH** is compliant to the directive 2011/65/EU on the Restriction of the use of certain Hazardous Substances (RoHS II) in electrical and electronic equipment



Component Recognition UL 60950-1

The **ETX® 3.0** form factor Computer-on-Modules are Recognized by Underwriters Laboratories Inc. Representative samples of this component have been evaluated by UL and meet applicable UL requirements.

UL Listings:

» [NWGQ2.E304278](#)

» [NWGQ8.E304278](#)



WEEE Directive

WEEE Directive 2002/96/EC is not applicable for Computer-on-Modules.

Conformal Coating

Conformal Coating is available for Kontron Computer-on-Modules and for validated SO-DIMM memory modules. Please contact your local sales or support for further details.

Shock & Vibration

The **ETX® 3.0** form factor Computer-on-Modules successfully passed shock and vibration tests according to

- » IEC/EN 60068-2-6 (Non operating Vibration, sinusoidal, 10Hz-4000Hz, +/-0.15mm, 2g)
- » IEC/EN 60068-2-27 (Non operating Shock Test, half-sinusoidal, 11ms, 15g)

EMC

Validated in Kontron reference housing for EMC the **ETX®-OH** follows the requirements for electromagnetic compatibility standards

- » EN55022

3.7 MTBF

The following MTBF (Mean Time Before Failure) values were calculated using a combination of manufacturer's test data, if the data was available, and the Telcordia (Bellcore) issue 2 calculation for the remaining parts.

The calculation method used is "Bellcore Method 1 Case 1" in a ground benign, controlled environment (GB,GC). This particular method takes into account varying temperature and stress data and the system is assumed to have not been burned in.

Other environmental stresses (extreme altitude, vibration, salt water exposure, etc) lower MTBF values.

System MTBF (hours): 212866 @ 40°C



Fans usually shipped with Kontron Europe GmbH products have 50,000-hour typical operating life. The above estimates assume no fan, but a passive heat sinking arrangement. Estimated RTC battery life (as opposed to battery failures) is not accounted for in the above figures and need to be considered separately. Battery life depends on both temperature and operating conditions. When the Kontron unit has external power; the only battery drain is from leakage paths.

3.8 Mechanical Specification

- » 95.0 mm x 114.0 mm
- » Hight approx. 12mm (0.4")

 CAD drawings are available at [EMD CustomerSection](#)

3.9 Module Dimensions

- » Height on Top Standard: 5.50mm (SATA connector)
- » Max Height on Top: 6.50mm (DisplayPort connector instead FlatFoil)
- » Height on Bottom: 2mm

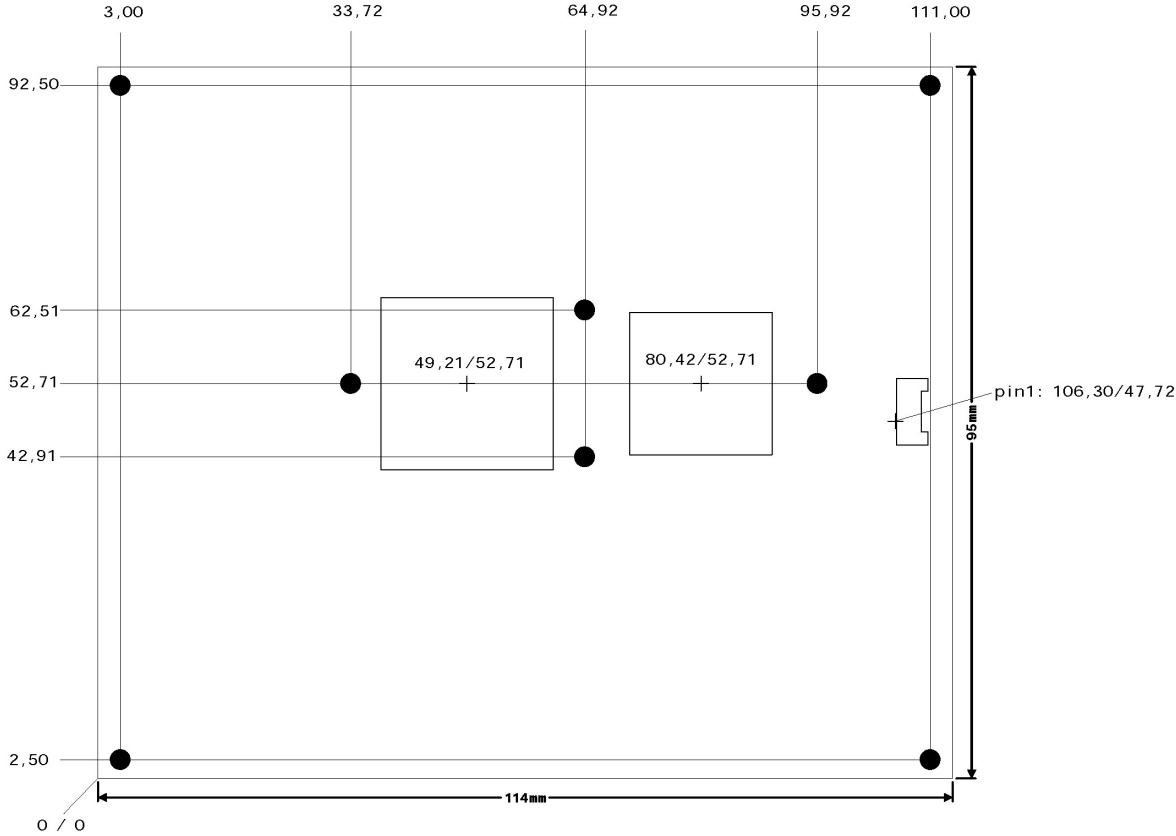

3.10 Thermal Management, Heatspreader and Cooling Solutions

A heatspreader plate assembly is available from Kontron Europe GmbH for the ETX®-OH. The heatspreader plate on top of this assembly is NOT a heat sink. It works as a ETX® 3.0-standard thermal interface to use with a heat sink or external cooling devices.

External cooling must be provided to maintain the heatspreader plate at proper operating temperatures. Under worst-case conditions, the cooling mechanism must maintain an ambient air and heatspreader plate temperature on any spot of the heatspreader's surface according the module specifications:

- » 60°C for commercial grade modules
- » 75°C for extended temperature grade modules (E1)
- » 85°C for industrial temperature grade modules (E2/XT)

The aluminum slugs and thermal pads or the heat-pipe on the underside of the heatspreader assembly implement thermal interfaces between the heatspreader plate and the major heat-generating components on the ETX®-OH. About 80 percent of the power dissipated within the module is conducted to the heatspreader plate and can be removed by the cooling solution.

You can use many thermal-management solutions with the heatspreader plates, including active and passive approaches. The optimum cooling solution varies, depending on the ETX® 3.0 application and environmental conditions. Active or passive cooling solutions provided from Kontron Europe GmbH for the ETX®-OH are usually designed to cover the power and thermal dissipation for a commercial grade temperature range used in a housing with proper air flow.

Documentation and CAD drawings of ETX®-OH heatspreader and cooling solutions are provided at <http://emdcustomersection.kontron.com>.

3.11 Onboard Connectors

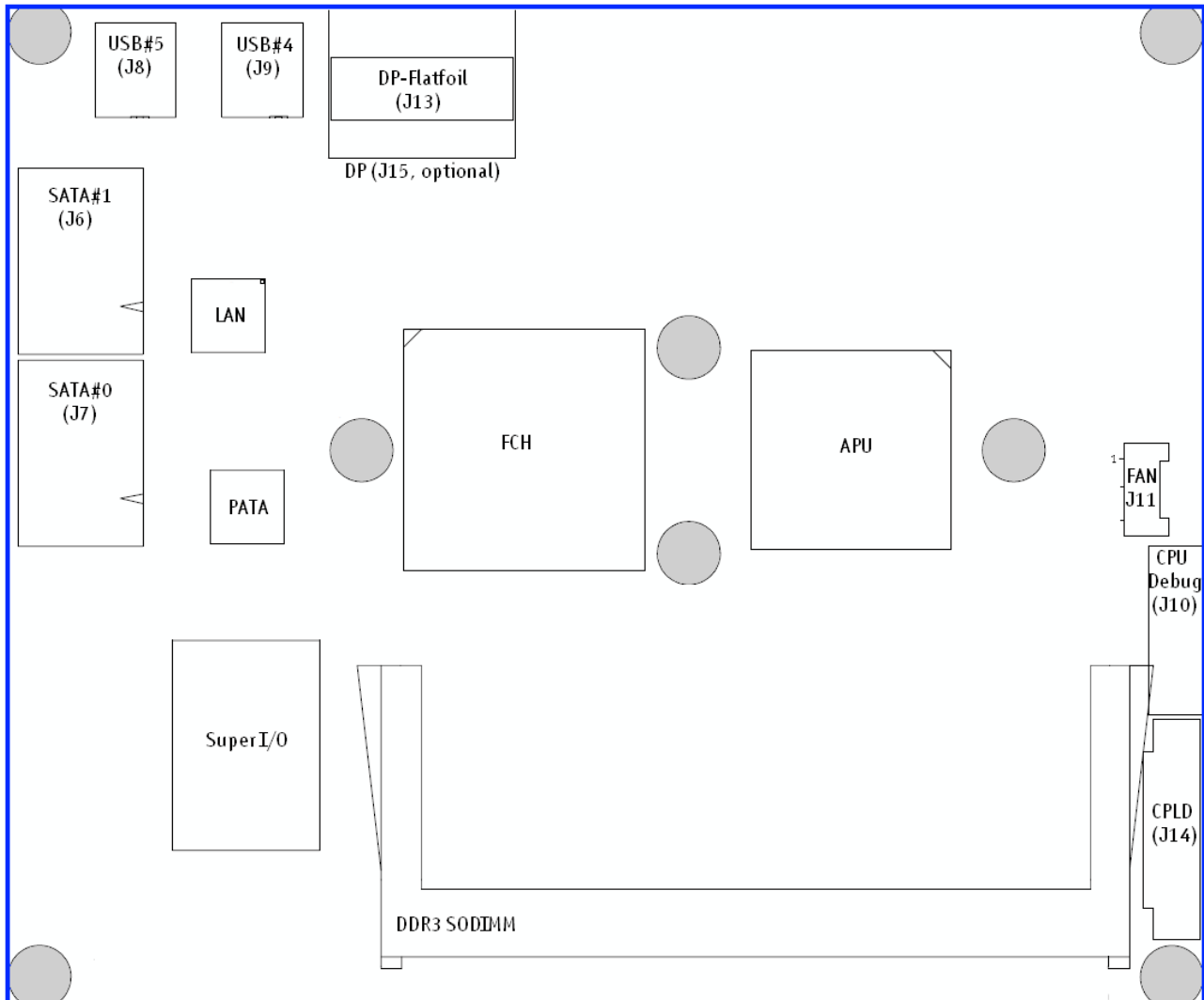

3.11.1 FAN

With certain BIOS-settings it is possible to control the fan depending on the Active Trip Point temperature. The fan switches on/off depending on the adjusted Active Trip Point temperature. In order for this feature to function properly an ACPI compliant OS is necessary.

The onboard fan connector (J11) has following Pin assignment:

- » Pin1: Tacho
- » Pin2: VCC
- » Pin3: GND

Electrical Characteristics

- » FAN VCC = 5 V



To connect a standard FAN with 3pin connector to the module please use adaptor cable KAB-HSP 200mm (96079-0000-00-0) or KAB-HSP 40mm (96079-0000-00-2)

3.11.2 SATA

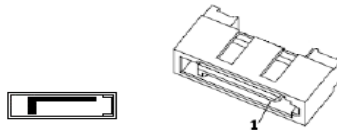

According the latest ETX® specification 3.0 the ETX®-OH provides two onboard SATA 3Gbps Ports with standard SATA pin-out

SATA PIN	Signal
1	Ground
2	Transmit+
3	Transmit-
4	Ground
5	Receive-
6	Receive+
7	Ground

3.11.3 USB

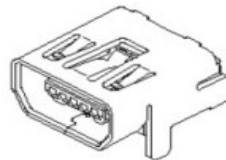

The ETX®-OH optionally supports two onboard USB 2.0 Mini-AB connectors J8 & J9. The Mini-AB USB On-The-Go (OTG) allows additional Hi-Speed USB support for external devices.

3.11.4 DisplayPort

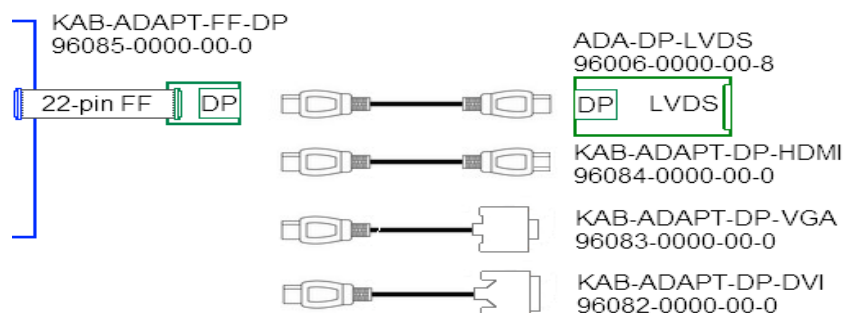

For external high-resolution displays the ETX®-OH supports an onboard connection for DisplayPort additionally to VGA and LDVS. By default the module is equipped with the 22-pin FlatFoil solution for best compatibility to existing ETX® carrier boards without having mechanical connectivity problems. The Flatfoil-to-DisplayPort cable KAB-ADAPT-FF-DP allows connectivity of standard DisplayPort, HDMI, DVI, VGA or LVDS via the Kontron DisplayPort-to-LVDS Konverter:

Alternatively, a combination shape allows the usage of a standard DisplayPort connector (J15) instead of the 22-pin Flatfoil directly on the module.



Please contact your local sales or support for customized variants with mini USB ports or DisplayPort

3.11.5 CPU Debug & CPLD

The CPU Debug connector J10 and the CPLD programming interface J14 are for internal use only and should not be used.

4 Features and Interfaces

4.1 Onboard SSD

The ETX®-OH features an onboard Greenliant SATA NAND flash drive with capacities of 2-32GB SLC or 2-64GB MLC optional. Due to performance and longevity reasons standard variants with onboard flash use SLC type only. The following SATA NANDrives are available:

Basic features of the SATA NANDrives

- » ATA/ATAPI-8 compliant Host interface with 48-bit address feature set and SMART support
- » RoHS compliant NAND flash type
- » SATA 1.5Gb/s Host transfer rate
- » Hardware error detection, correction ECC and advanced wear leveling
- » Bad block management
- » TRIM support
- » SMART support
- » 0°C to +70°C temperature range for MLC types A-M-C/B-M-C
- » -40°C to +85°C temperature range for MLC types B-M-I
- » -40°C to +85°C temperature range for all SLC types

Single-level Cell (SLC) NANDrive™

Flash Part No.	GLS85LS				
Flash Part No.	1002P-S-I-FZJE-ND104	1004P-S-I-FZJE-ND104	1008P-S-I-FZJE-ND104	1016P-S-I-FZJE-ND104	1032P-S-I-FZJE-ND104
Product Revision	CC1	CC1	CC1	CC1	CC1
Flash Size	2GByte	4GByte	8GByte	16GByte	32GByte
Burst Read/Write Speed	35/20 MB/s	70/35 MB/s	70/50 MB/s	70/55 MB/s	120/80 MB/s
Total Bytes	2,000,388,096	4,001,292,288	8,012,390,400	16,013,942,784	32,017,047,552
Active Mode Power	450mW	560mW	750mW	590mW	855mW
Typical P/E Cycles per block	100,000	100,000	60,000	60,000	60,000

(Data based on Datasheet S71432 Rev. 03.100 from 11-2013 and S71445 Rev. 01.400 from 11-2013)

Multi-level Cell (MLC) NANDrive™

Flash Part No.	GLS85LS					
Flash Part No.	1002A-M-C-FZJE-ND103 1002A-M-I-FZJE-ND103	1004A-M-C-FZJE-ND103 1004A-M-I-FZJE-ND103	1008B-M-C-FZJE-ND103 1008B-M-I-FZJE-ND103	1016B-M-C-FZJE-ND103 1016B-M-I-FZJE-ND103	1032B-M-C-FZJE-ND103 1032B-M-I-FZJE-ND103	1064B-M-C-FZJE-ND103 1064B-M-I-FZJE-ND103
Product Revision	CB2	CB2	CB2	CB2	CB2	CB2
Flash Size	2GByte	4GByte	8GByte	16GByte	32GByte	64GByte
Burst Read/Write Speed	35/10 MB/s	35/10 MB/s	35/10 MB/s	70/20 MB/s	70/30 MB/s	110/60 MB/s
Total Bytes	1,941,553,152	3,941,941,248	8,012,390,400	16,013,942,784	32,017,047,552	64,023,257,088
Active Mode Power	360mW	360mW	360mW	440mW	565mW	820mW
Typical P/E Cycles per block	5,000	5,000	5,000	5,000	5,000	5,000

(Data based on Datasheet S71430 Rev 02.00 from 10-2013)

4.2 S5 Eco Mode

Kontron's new high-efficient power-off state S5 Eco enables lowest power-consumption in soft-off state – less than 1 mA compared to the regular S5 state this means a reduction by at least factor 200!

In the "normal" S5 mode the board is supplied by 5V_Stb and needs usually up to 300mA just to stay off. This mode allows to be switched on by power button and RTC event, even when it is not necessary. The new S5 Eco mode reduces the current enormous.

The S5 Eco Mode can be enabled in BIOS Setup, when the BIOS supports this feature.

Following prerequisites and consequences occur when S5 Eco Mode is enabled

- » The power button must be pressed at least for 200ms to switch on.
- » Wake via Power button only.
- » "Power On After Power Fail"/"State after G3": only "stay off" is possible

4.3 M.A.R.S.

The Smart Battery implementation for Kontron Computer-on-Modules called **M**obile **A**pplication for **R**echargeable **S**ystems is a BIOS extension for external Smart Battery Manager or Charger. It includes support for SMBus charger/selector (e.g. Linear Technology LTC1760 Dual Smart Battery System Manager) and provides ACPI compatibility to report battery information to the Operating System.

Reserved SM-Bus addresses for Smart Battery Solutions on the carrier:

8-bit Address	7-bit Address	Device
12h	0x09	SMART_CHARGER
14h	0x0A	SMART_SELECTOR
16h	0x0B	SMART_BATTERY

4.4 Fast I2C

The ETX®-0H supports a CPLD implemented LPC to I2C bridge using the WISHBONE I2C Master Core provided from opencores.org. The I2C Interface supports transfer rates up to 40kB/s and can be configured in Setup

Specification for external I2C:

- » Speed up to 400kHz
- » Compatible to Philips I2C bus standard
- » Multi-Master capable
- » Clock stretching support and wait state generation
- » Interrupt or bit-polling driven byte-by-byte data-transfers
- » Arbitration lost interrupt with automatic transfer cancellation
- » Start/Stop signal generation/detection
- » Bus busy detection
- » 7bit and 10bit addressing

4.5 EAPI, JIDA & PLD Driver

K-Station 2 including the Kontron PLD / Board Driver for new generation modules with UEFI is a replacement for former JIDA16/JIDA32 BIOS implementations. It consists of hardware drivers providing access to features like Watchdog, I2C Bus or GPIO implemented in the onboard Programmable Logic Device (CPLD). The Board Driver supports the official PICMG embedded API (EAPI) and for backwards compatibility the former used Kontron JIDA32 API. The driver (Cpld.sys) and API (Eapi.dll/Jida.dll) is available for Windows and for Linux.

Usage Model

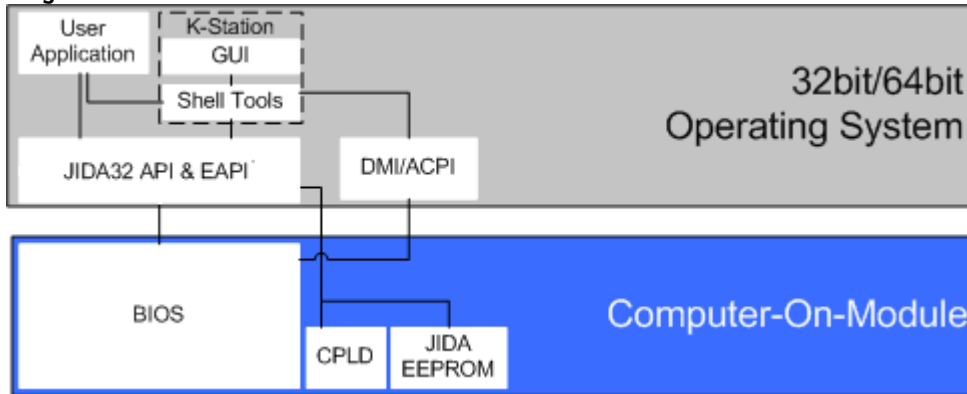

4.6 K-Tools

For easy access to the API Kontron provides Windows Shell Utilities, the so called K-Tools, for direct access to the JIDA32 interface via the Windows command line.

Available K-Station 2 Shell Tools:

- » KEthernet.exe (LAN Information)
- » KGenInfo.exe (Module Information)
- » KHWMon.exe (Hardware Monitoring)
- » KI2CBus.exe (I2C and SMBus access)
- » KIOPort.exe (GPIO control)
- » KStorage.exe (JIDA EEPROM access to user bytes)
- » KSystemSummary.exe (System Information)
- » KVGATool.exe (LVDS Backlight control)
- » KWDog.exe (Watchdog control)

K-Station 2 is available on [EMD Customer Section](#). The Installer allows following installation methods:

- » Light Target Installation for JIDA32 and EAPI driver only
- » Medium Target Installation for JIDA32 and EAPI with K-Tools
- » Host Installation with Sources and Documentation

For silent installation use command

- » `msiexec /quiet /i K-Station_2xxx_xxx.msi`

4.7 K-Station 2 GUI

As an example utility Kontron provides the K-Station 2 GUI for 32 and 64bit Windows. K-Station 2 GUI is a JAVA based example Graphical User Interface using the K-Tools in Remote Mode. It allows easy and fast evaluation of board specific features supported by the API and PLD Driver.

4.8 KeAPI

The Kontron embedded API (KeAPI) is an extension of the PICMG EAPI mainly with additional remote functionality. It consists of hardware drivers providing access to features like Watchdog, I2C Bus or GPIO and a QT based user interface KEAPI GUI. KeAPI is part of standard BSPs for modules based on AMI APTIO (UEFI).

Please refer to [EMD Customer Section](#) for detailed documentation and downloads.

Usage of KeAPI

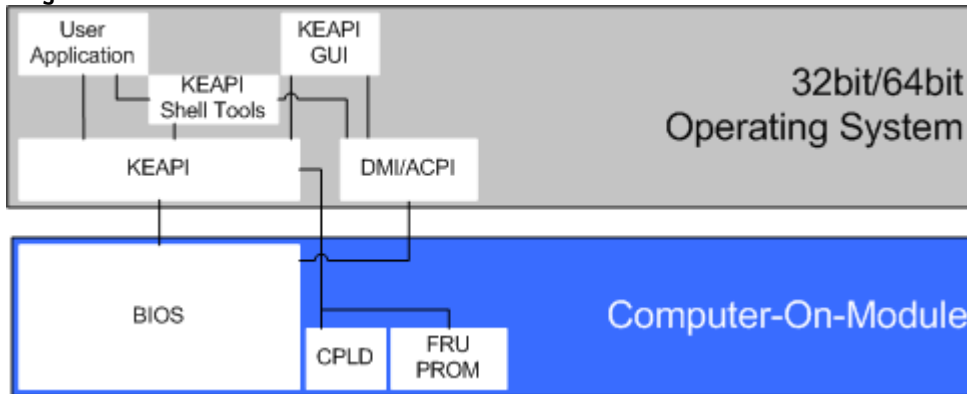

4.9 Watchdog Timer

You can configure the Watchdog Timer (WDT) in BIOS setup to start after a set amount of time after power-on boot. The WDT can also be controlled by the JIDA32 Library API. The application software should strobe the WDT to prevent its timeout. Upon timeout, the WDT resets and restarts the system. This provides a way to recover from program crashes or lockups.

Configuration

You can program the timeout period for the watchdog timer in two ranges:

- » 1-second increments from 1 to 255 seconds
- » 1-minute increments from 1 to 255 minutes

Contact Kontron Embedded Modules technical support for information on programming and operating the WDT.

4.10 C-States

New generation platforms include power saving features like SuperLFM, EIST (P-States) or C-States in O/S idle mode.

Activated C-States are able to dramatically decrease power consumption in idle mode by reducing the Core Voltage or switching of parts of the CPU Core, the Core Clocks or the CPU Cache.

Following C-States are defined:

C-State	Description	Function
C0	Operating	CPU fully turned on
C1	Halt State	Stops CPU main internal clocks via software
C1E	Enhanced Halt	Similar to C1, additionally reduces CPU voltage
C2	Stop Grant	Stops CPU internal and external clocks via hardware
C2E	Extended Stop Grant	Similar to C2, additionally reduces CPU voltage
C3	Deep Sleep	Stops all CPU internal and external clocks
C3E	Extended Stop Grant	Similar to C3, additionally reduces CPU voltage
C4	Deeper Sleep	Reduces CPU voltage
C4E	Enhanced Deeper Sleep	Reduces CPU voltage even more and turns off the memory cache
C6	Deep Power Down	Reduces the CPU internal voltage to any value, including 0V
C7	Deep Power Down	Similar to C6, additionally LLC (LastLevelCache) is switched off

C-States are usually enabled by default for low power consumption, but active C-States may influence performance sensitive applications or real-time systems.

- » Active C6-State may influence data transfer on external Serial Ports
- » Active C7-State may cause lower CPU and Graphics performance

It's recommended to disable C-States / Enhanced C-States in BIOS Setup if any problems occur.

4.11 ACPI Suspend Modes and Resume Events

The ETX@-OH supports the S-states S0, S3, S4, S5. S5eco Support: -

The following events resume the system from S3:

- » USB Keyboard (1)
- » USB Mouse (1)
- » Power Button
- » WakeOnLan (2)

The following events resume the system from S4:

- » Power Button
- » WakeOnLan (2)

The following events resume the system from S5:

- » Power Button

The following events resume the system from S5Eco:

- » Power Button



- (1) OS must support wake up via USB devices and baseboard must power the USB Port with StBy-Voltage
- (2) Depending on the Used Ethernet MAC/Phy WakeOnLan must be enabled in BIOS setup and driver options

5 System Resources

5.1 Interrupt Request (IRQ) Lines

IRQ #	Used For	Available	Comment
0	Timer0	No	-
1	Keyboard	No	-
2	Cascade	No	-
3	COM2	Dynamic	Onboard SIO (Note 1)
4	COM1	Dynamic	Onboard SIO (Note 1)
5	-	YES	-
6	FDC	Dynamic	Onboard SIO (Note 1)
7	LPT	Dynamic	Onboard SIO (Note 1)
8	RTC	No	-
9	ACPI	No	-
10	COM4	Dynamic	External SIO (Note 1)
11	COM3	Dynamic	External SIO (Note 1)
12	PS/2 Mouse	No	-
13	FPU	No	-
14	ATA Channel 0	No	Note (3)
15	ATA Channel 1	No	Note (3)
16	LNK A	No	PCIe RP 0 + HDAudio + PATA Ch#0; Note(4)
17	LNK B	No	PCIe RP 1 + USB EHCI (#1 #2 #3)+ PATA Ch#1 + SATA Legacy IDE; Note(4)
18	LNK C	No	AMD Radeon GFX + USB OHCI (#1 #2 #3 #4) + GbE; Note(4)
19	LNK D	No	SATA + HD Audio; Note(4)
20	LNK E	Yes	PCI INTA Note(4)
21	LNK F	Yes	PCI INTB Note(4)
22	LNK G	Yes	PCI INTC Note(4)
23	LNK H	Yes	PCI INTD Note(4)



- (1) If the “Used For” device is disabled in setup, the corresponding interrupt is available for other device.
- (2) Only one of the two devices can be used at the same time as they share pins.
- (3) Unavailable in SATA legacy mode.
- (4) ACPI OS decides on particular IRQ usage

5.2 Memory Area

Upper Memory	Used for	Available	Comment
A0000h – BFFFFh	VGA Memory	No	Mainly used by graphic controller
C0000h – CFFFFh	VGA BIOS	No	Used by onboard VGA ROM
E0000h – FFFFFh	System BIOS	No	Fixed
B8000000h–CFFFFFFFh	System	No	Fixed
D0000000h–DFFFFFFFh	AMD Radeon GFX	No	Fixed
D0000000h–FEBFFFFFFh	PCIe Config Space	No	Fixed
FEC00000h–FEC000EFh	IOxAPIC	No	Fixed
FEC000F0h–FEC00FFFh	System	No	Fixed
FEC100F0h–FEC10FFFh	System	No	Fixed
FED00000h–FED003FFh	HPET	No	Fixed
FED00400h–FED00FFFh	System	No	Fixed
FED40000h–FED44FFFh	TPM	No	Fixed
FED45000h–FED8FFFFh	TPM	No	Fixed
FED61000h–FED70FFFh	System	No	Fixed
FED80000h–FED80FFFh	System	No	Fixed
FEE00000h–FEE00FFFh	System	No	Fixed
FFC00000h–FFFFFFFh	BIOS Flash	No	Fixed

5.3 I/O Address Map

The I/O-port addresses of the are functionally identical to a standard PC/AT. All addresses not mentioned in this table should be available. We recommend that you do not use I/O addresses below 0100h with additional hardware for compatibility reasons, even if available.

I/O Address	Used for	Available	Comment
0000 - 001F	System Ressources	No	Fixed
0020 - 0021	Interrupt Controller 1	No	Fixed
0022 - 003F	System Ressources	No	Fixed
002E - 002F	SIO	No	Fixed
0040 - 0043	Timer, Counter	No	Fixed
0044 - 005F	System Ressources	No	Fixed
004E - 004F	TPM	No	Fixed
0060 - 0060	Keyboard controller	No	Fixed
0061 - 0061	System Speaker	No	Fixed
0062 - 0063	System Ressources	No	Fixed
0064 - 0064	Keyboard controller	No	Fixed
0065 - 006F	System Ressources	No	Fixed
0070 - 007F	RTC and CMOS Registers	No	Fixed
0080	BIOS Postcode	No	Fixed
0081 - 009F	DMA Controller	No	Fixed
00A0 - 00BF	Interrupt Controller	No	Fixed
00C0 - 00DF	DMA Controller	No	Fixed
00E0 - 00EF	System Ressources	No	Fixed
00F0 - 00FF	Math Coprocessor	No	Fixed
0290 - 029F	SIO	No	Fixed
02E8 - 02EF	External SIO COM4	Not with ext. SIO	Fixed
03B0 - 03DF	VGA	No	Fixed
03E8 - 03EF	External SIO COM3	Not with ext. SIO	Fixed
040B - 040B	Chipset	No	Fixed
04D0 - 04D1	Chipset	No	Fixed
04D6 - 04D6	Chipset	No	Fixed
0800 - 089F	Chipset	No	Fixed
0900 - 090F	Chipset	No	Fixed
0910 - 091F	Chipset	No	Fixed
0B20 - 0B3F	Chipset	No	Fixed
0C00 - 0C01	Chipset	No	Fixed
0C14	Chipset	No	Fixed
0C50 - 0C52	Chipset	No	Fixed
0C6C	Chipset	No	Fixed
0C6F	Chipset	No	Fixed
0CD0 - 0CDF	Chipset	No	Fixed

6 ETX® Connectors

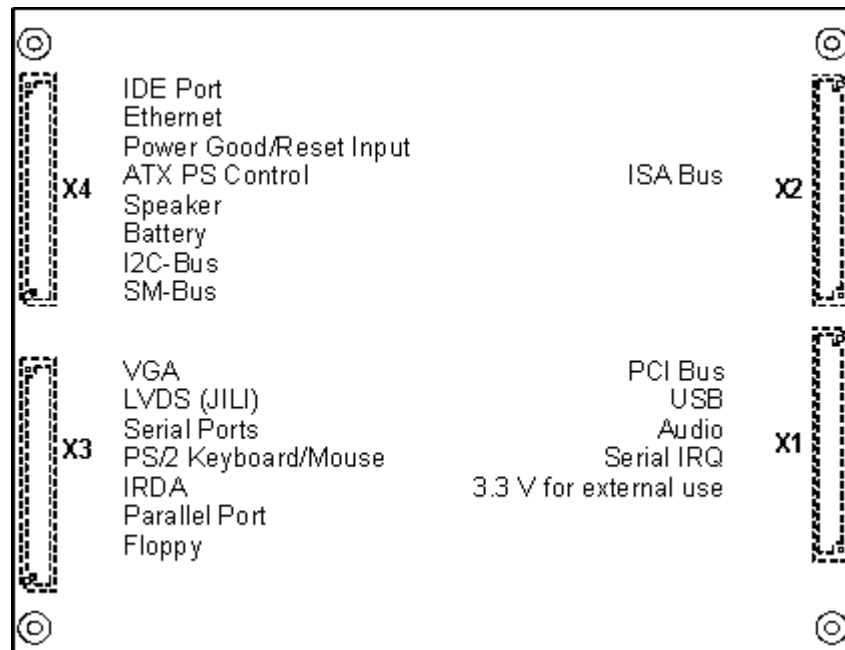

The pinouts for ETX® Interface Connectors X1, X2, X3, and X4 are documented for convenient reference. Please see the ETX® Specification and ETX® Design Guide for detailed, design-level information.

6.1 General Signal Description

Term	Description
I0-3,3	Bi-directional 3,3 V IO-Signal
I0-5	Bi-directional 5 V IO-Signal
I-3,3	3,3 V Input
I-5	5 V Input
O-3,3	3,3 V Output
O-5	5 V Output
PU	Pull-Up Resistor
PD	Pull-Down Resistor
PWR	Power Connection
Nc	Not Connected / Reserved

6.2 Connector X1 (PCI bus, USB, Audio)

Pin	Signal	Pin	Signal	Pin	Signal	Pin	Signal
1	GND	2	GND	51	VCC *	52	VCC *
3	PCICLK3	4	PCICLK4	53	PAR	54	SERR#
5	GND	6	GND	55	GPERR#	56	RESERVED
7	PCICLK1	8	PCICLK2	57	PME#	58	USB2#
9	REQ3#	10	GNT3#	59	LOCK#	60	DEVSEL#
11	GNT2#	12	3V	61	TRDY#	62	USB3#
13	REQ2#	14	GNT1#	63	IRDY#	64	STOP#
15	REQ1#	16	3V	65	FRAME#	66	USB2
17	GNT0#	18	RESERVED	67	GND	68	GND
19	VCC *	20	VCC *	69	AD16	70	CBE2#
21	SERIRQ	22	REQ0#	71	AD17	72	USB3
23	AD0	24	3V	73	AD19	74	AD18
25	AD1	26	AD2	75	AD20	76	USB0#
27	AD4	28	AD3	77	AD22	78	AD21
29	AD6	30	AD5	79	AD23	80	USB1#
31	CBE0#	32	AD7	81	AD24	82	CBE3#
33	AD8	34	AD9	83	VCC *	84	VCC *
35	GND	36	GND	85	AD25	86	AD26
37	AD10	38	AUXAL	87	AD28	88	USB0
39	AD11	40	MIC	89	AD27	90	AD29
41	AD12	42	AUXAR	91	AD30	92	USB1
43	AD13	44	ASVCC	93	PCIRST#	94	AD31
45	AD14	46	SNDL	95	INTC#	96	INTD#
47	AD15	48	ASGND	97	INTA#	98	INTB#
49	CBE1#	50	SNDR	99	GND	100	GND

* To protect external power lines of peripheral devices, make sure that:



- the wires have the right diameter to withstand the maximum available current
- the enclosure of the peripheral device fulfils the fire-protection requirements of IEC/EN60950

6.2.1 Connector X1 Signal Levels

Pin	Signal	Description	Type	Termination	Comment
1	GND	Ground	PWR	-	-
2	GND	Ground	PWR	-	-
3	PCICLK3	PCI Clock Slot 3	O-3,3	-	-
4	PCICLK4	PCI Clock Slot 4	O-3,3	-	-
5	GND	Ground	PWR	-	-
6	GND	Ground	PWR	-	-
7	PCICLK1	PCI Clock Slot 1	O-3,3	-	-
8	PCICLK2	PCI Clock Slot 2	O-3,3	-	-
9	REQ3#	PCI Bus Request 3	I-3,3	PU 15k 3.3V	15k Ohm Resistors
10	GNT3#	PCI Bus Grant 3	O-3,3	-	-
11	GNT2#	PCI Bus Grant 2	O-3,3	-	-
12	3V	Power +3,3V	PWR	-	-
13	REQ2#	PCI Bus Request 2	I-3,3	-	int. PU 15k in A55E
14	GNT1#	PCI Bus Grant 1	O-3,3	-	-
15	REQ1#	PCI Bus Request 1	I-3,3	-	int. PU 15k in A55E
16	3V	Power +3,3V	PWR	-	-
17	GNT0#	PCI Bus Grant 0	O-3,3	-	-
18	nc	-	nc	-	Reserved
19	VCC	Power +5V	PWR	-	-
20	VCC	Power +5V	PWR	-	-
21	SERIRQ	Serial Interrupt Request	IO-3,3	-	int. PU 8k2 in A55E
22	REQ0#	PCI Bus Request 0	I-3,3	-	int. PU 15k in A55E
23	AD0	PCI Address & Data Bus line	IO-3,3	-	-
24	3V	Power +3,3V	PWR	-	-
25	AD1	PCI Address & Data Bus line	IO-3,3	-	-
26	AD2	PCI Address & Data Bus line	IO-3,3	-	-
27	AD4	PCI Address & Data Bus line	IO-3,3	-	-
28	AD3	PCI Address & Data Bus line	IO-3,3	-	-
29	AD6	PCI Address & Data Bus line	IO-3,3	-	-
30	AD5	PCI Address & Data Bus line	IO-3,3	-	-
31	CBE0#	PCI Bus Command and Byte enables 0	IO-3,3	-	-
32	AD7	PCI Address & Data Bus line	IO-3,3	-	-
33	AD8	PCI Address & Data Bus line	IO-3,3	-	-
34	AD9	PCI Address & Data Bus line	IO-3,3	-	-
35	GND	Ground	PWR	-	-
36	GND	Ground	PWR	-	-
37	AD10	PCI Address & Data Bus line	IO-3,3	-	-
38	AUXAL	Auxiliary Line Input Left	I	-	-
39	AD11	PCI Address & Data Bus line	IO-3,3	-	-
40	MIC	Microphone Input	I	-	-
41	AD12	PCI Address & Data Bus line	IO-3,3	-	-
42	AUXAR	Auxiliary Line Input Right	I	-	-
43	AD13	PCI Address & Data Bus line	IO-3,3	-	-
44	ASVCC	Analog Supply of Sound Controller	O-5	-	-
45	AD14	PCI Address & Data Bus line	IO-3,3	-	-
46	SNDL	Audio Out Left	O	-	-
47	AD15	PCI Address & Data Bus line	IO-3,3	-	-
48	ASGND	Analog Ground of Sound Controller	PWR	-	-
49	CBE1#	PCI Bus Command and Byte enables 1	IO-3,3	-	-
50	SNDR	Audio Out Right	O	-	-
51	VCC	Power +5V	PWR	-	-
52	VCC	Power +5V	PWR	-	-
53	PAR	PCI Bus Parity	IO-3,3	-	-
54	SERR#	PCI Bus System Error	IO-3,3	-	int. PU 8k2 in A55E
55	GPERR#	PCI Bus Grant Error	IO-3,3	-	int. PU 8k2 in A55E
56	nc	-	nc	-	Reserved
57	PME#	PCI Power Management Event	IO-3,3	-	int. PU 10k in A55E
58	USB2#	USB Data-, Port2	IO-3,3	-	-
59	LOCK#	PCI Bus Lock	IO-3,3	-	int. PU 8k2 in A55E
60	DEVSEL#	PCI Bus Device Select	IO-3,3	-	int. PU 8k2 in A55E
61	TRDY#	PCI Bus Target Ready	IO-3,3	-	int. PU 8k2 in A55E
62	USB3#	USB Data-, Port3	IO-3,3	-	-
63	IRDY#	PCI Bus Initiator Ready	IO-3,3	-	int. PU 8k2 in A55E
64	STOP#	PCI Bus Stop	IO-3,3	-	int. PU 8k2 in A55E

65	FRAME#	PCI Bus Cycle Frame	IO-3,3	-	int. PU 8k2 in A55E
66	USB2	USB Data+ , Port2	IO-3,3	-	-
67	GND	Ground	PWR	-	-
68	GND	Ground	PWR	-	-
69	AD16	PCI Adress & Data Bus line	IO-3,3	-	-
70	CBE2#	PCI Bus Command and Byte enables 2	IO-3,3	-	-
71	AD17	PCI Adress & Data Bus line	IO-3,3	-	-
72	USB3	USB Data+ , Port3	IO-3,3	-	-
73	AD19	PCI Adress & Data Bus line	IO-3,3	-	-
74	AD18	PCI Adress & Data Bus line	IO-3,3	-	-
75	AD20	PCI Adress & Data Bus line	IO-3,3	-	-
76	USB0#	USB Data- , Port0	IO-3,3	-	-
77	AD22	PCI Adress & Data Bus line	IO-3,3	-	-
78	AD21	PCI Adress & Data Bus line	IO-3,3	-	-
79	AD23	PCI Adress & Data Bus line	IO-3,3	-	int. PU 15k in A55E
80	USB1#	USB Data- , Port1	IO-3,3	-	-
81	AD24	PCI Adress & Data Bus line	IO-3,3	-	int. PU 15k in A55E
82	CBE3#	PCI Command and Byte enables 3	IO-3,3	-	-
83	VCC	Power +5V	PWR	-	-
84	VCC	Power +5V	PWR	-	-
85	AD25	PCI Adress & Data Bus line	IO-3,3	-	-
86	AD26	PCI Adress & Data Bus line	IO-3,3	-	int. PU 15k in A55E
87	AD28	PCI Adress & Data Bus line	IO-3,3	-	-
88	USB0	USB Data+ , Port0	IO-3,3	-	-
89	AD27	PCI Adress & Data Bus line	IO-3,3	-	int. PU 15k in A55E
90	AD29	PCI Adress & Data Bus line	IO-3,3	-	-
91	AD30	PCI Adress & Data Bus line	IO-3,3	-	-
92	USB1	USB Data+ , Port1	IO-3,3	-	-
93	PCIRST#	PCI Bus Reset	O-3,3	-	-
94	AD31	PCI Adress & Data Bus line	IO-3,3	-	-
95	INTC#	PCI BUS Interrupt Request C	I-3,3	-	int. PU 8k2 in A55E
96	INTD#	PCI BUS Interrupt Request D	I-3,3	-	int. PU 8k2 in A55E
97	INTA#	PCI BUS Interrupt Request A	I-3,3	-	int. PU 8k2 in A55E
98	INTB#	PCI BUS Interrupt Request B	I-3,3	-	int. PU 8k2 in A55E
99	GND	Ground	PWR	-	-
100	GND	Ground	PWR	-	-



The termination resistors in this table are already mounted on the ETX® board. Please refer to the design guide for information about additional termination resistors.



PCI-Bus pins are 5V tolerant.

6.3 Connector X2 (ISA Bus)

Pin	Signal	Pin	Signal	Pin	Signal	Pin	Signal
1	GND	2	GND	51	VCC *	52	VCC 1)
3	SD14	4	SD15	53	SA6	54	IRQ5
5	SD13	6	MASTER#	55	SA7	56	IRQ6
7	SD12	8	DREQ7	57	SA8	58	IRQ7
9	SD11	10	DACK7#	59	SA9	60	SYSCLK
11	SD10	12	DREQ6	61	SA10	62	REFSH#
13	SD9	14	DACK6#	63	SA11	64	DREQ1
15	SD8	16	DREQ5	65	SA12	66	DACK1#
17	MEMW#	18	DACK5#	67	GND	68	GND
19	MEMR#	20	DREQ0	69	SA13	70	DREQ3
21	LA17	22	DACK0#	71	SA14	72	DACK3#
23	LA18	24	IRQ14	73	SA15	74	IOR#
25	LA19	26	IRQ15	75	SA16	76	IOW#
27	LA20	28	IRQ12	77	SA18	78	SA17
29	LA21	30	IRQ11	79	SA19	80	SMEMR#
31	LA22	32	IRQ10	81	IOCHRDY	82	AEN
33	LA23	34	IO16#	83	VCC *	84	VCC *
35	GND	36	GND	85	SD0	86	SMEMW#
37	SBHE#	38	M16#	87	SD2	88	SD1
39	SA0	40	OSC	89	SD3	90	NOWS#
41	SA1	42	BALE	91	DREQ2	92	SD4
43	SA2	44	TC	93	SD5	94	IRQ9 2)
45	SA3	46	DACK2#	95	SD6	96	SD7
47	SA4	48	IRQ3	97	IOCHK#	98	RSTDRV
49	SA5	50	IRQ4	99	GND	100	GND

1) To protect external power lines of peripheral devices, make sure that:

- The wires have the right diameter to withstand the maximum available current.
- The enclosure of the peripheral device fulfils the fire-protection requirements of IEC/EN60950



2) IRQ9 is used for SCI in ACPI mode. Do not use for legacy ISA devices.

6.3.1 Connector X2 Signal Levels

Pin	Signal	Description	Type	Termination	Comment
1	GND	Ground	PWR	-	-
2	GND	Ground	PWR	-	-
3	SD14	ISA Data Bus	IO-5	PU 8k2 5V	-
4	SD15	ISA Data Bus	IO-5	PU 8k2 5V	-
5	SD13	ISA Data Bus	IO-5	PU 8k2 5V	-
6	MASTER#	ISA 16-Bit Master	I-5	PU 330R 5V	-
7	SD12	ISA Data Bus	IO-5	PU 8k2 5V	-
8	DREQ7	ISA DMA Request 7	I-5	PD 8k2	-
9	SD11	ISA Data Bus	IO-5	PU 8k2 5V	-
10	DACK7#	ISA DMA Acknowledge 7	O-5	-	-
11	SD10	ISA Data Bus	IO-5	PU 8k2 5V	-
12	DREQ6	ISA DMA Request 6	I-5	PD 8k2	-
13	SD9	ISA Data Bus	IO-5	PU 8k2 5V	-
14	DACK6#	ISA DMA Acknowledge 6	O-5	-	-
15	SD8	ISA Data Bus	IO-5	PU 8k2 5V	-
16	DREQ5	ISA DMA Request 5	I-5	PD 8k2	-
17	MEMW#	ISA Memory Write	IO-5	PU 8k2 5V	-
18	DACK5#	ISA DMA Acknowledge 5	O-5	-	-
19	MEMR#	ISA Memory Read	IO-5	PU 8k2 5V	-
20	DREQ0	ISA DMA Request 0	I-5	PD 8k2	-
21	LA17	ISA Adress Bus (SA17)	IO-5	PU 8k2 5V	-
22	DACK0#	ISA DMA Acknowledge 0	O-5	-	-
23	LA18	ISA Adress Bus (SA18)	IO-5	PU 8k2 5V	-
24	IRQ14	ISA Interrupt Request 14 / ROM Chip Select	IO-5	PU 8k2 5V	-
25	LA19	ISA Adress Bus (SA19)	IO-5	PU 8k2 5V	-
26	IRQ15	ISA Interrupt Request 15	I-5	PU 8k2 5V	-
27	LA20	ISA Latchable Adress Bus	IO-5	-	-
28	IRQ12	ISA Interrupt Request 12	I-5	PU 8k2 5V	-
29	LA21	ISA Latchable Adress Bus	IO-5	-	-
30	IRQ11	ISA Interrupt Request 11	I-5	PU 8k2 5V	-
31	LA22	ISA Latchable Adress Bus	IO-5	-	-
32	IRQ10	ISA Interrupt Request 10	I-5	PU 8k2 5V	-
33	LA23	ISA Latchable Adress Bus	IO-5	-	-
34	IO16#	ISA 16-Bit I/O Access	I-5	PU 330R 5V	-
35	GND	Ground	PWR	-	-
36	GND	Ground	PWR	-	-
37	SBHE#	ISA System Byte High Enable	IO-5	PU 8k2 5V	-
38	M16#	ISA 16-Bit Memory Access	IO-5	PU 330R 5V	-
39	SA0	ISA Adress Bus	IO-5	PU 8k2 5V	-
40	OSC	ISA Oscillator	O-3,3	-	14.318MHz
41	SA1	ISA Adress Bus	IO-5	PU 8k2 5V	-
42	BALE	ISA Buffer Adress Latch Enable	IO-5	PD 4k7	-
43	SA2	ISA Adress Bus	IO-5	PU 8k2 5V	-
44	TC	ISA Terminal Count	IO-5	PD 4k7	-
45	SA3	ISA Adress Bus	IO-5	PU 8k2 5V	-
46	DACK2#	ISA DMA Acknowledge 2	O-5	-	-
47	SA4	ISA Adress Bus	IO-5	PU 8k2 5V	-
48	IRQ3	ISA Interrupt Request 3	I-5	PU 8k2 5V	-
49	SA5	ISA Adress Bus	IO-5	PU 8k2 5V	-
50	IRQ4	ISA Interrupt Request 4	I-5	PU 8k2 5V	-
51	VCC	Power +5V	PWR	-	-
52	VCC	Power +5V	PWR	-	-
53	SA6	ISA Adress Bus	IO-5	PU 8k2 5V	-
54	IRQ5	ISA Interrupt Request 5	I-5	PU 8k2 5V	-
55	SA7	ISA Adress Bus	IO-5	PU 8k2 5V	-
56	IRQ6	ISA Interrupt Request 6	I-5	PU 8k2 5V	-
57	SA8	ISA Adress Bus	IO-5	PU 8k2 5V	-
58	IRQ7	ISA Interrupt Request 7	I-5	PU 8k2 5V	-
59	SA9	ISA Adress Bus	IO-5	PU 8k2 5V	-
60	SYSCLK	ISA Bus Clock	O-5	-	8.25MHz
61	SA10	ISA Adress Bus	IO-5	PU 8k2 5V	-
62	REFSH#	ISA System Refresh Control	IO-5	PU 1k 5V	-
63	SA11	ISA Adress Bus	IO-5	PU 8k2 5V	-
64	DREQ1	ISA DMA Request 1	I-5	PD 8k2	-

65	SA12	ISA Adress Bus	IO-5	PU 8k2 5V	-
66	DACK1#	ISA DMA Acknowledge 1	O-5	-	-
67	GND	Ground	PWR	-	-
68	GND	Ground	PWR	-	-
69	SA13	ISA Adress Bus	IO-5	PU 8k2 5V	-
70	DREQ3	ISA DMA Request 3	I-5	PD 8k2	-
71	SA14	ISA Adress Bus	IO-5	PU 8k2 5V	-
72	DACK3#	ISA DMA Acknowledge 3	O-5	-	-
73	SA15	ISA Adress Bus	IO-5	PU 8k2 5V	-
74	IOR#	ISA I/O Read	IO-5	PU 8k2 5V	-
75	SA16	ISA Adress Bus	IO-5	PU 8k2 5V	-
76	IOW#	ISA I/O Write	IO-5	PU 8k2 5V	-
77	SA18	ISA Adress Bus	IO-5	PU 8k2 5V	-
78	SA17	ISA Adress Bus	IO-5	PU 8k2 5V	-
79	SA19	ISA Adress Bus	IO-5	PU 8k2 5V	-
80	SMEMR#	ISA System Memory Read	IO-5	PU 8k2 5V	-
81	IOCHRDY	ISA I/O Channel Ready	IO-5	PU 1k 5V	-
82	AEN	ISA Adress Enable	IO-5	PD 4k7	-
83	VCC	Power +5V	PWR	-	-
84	VCC	Power +5V	PWR	-	-
85	SD0	ISA Data Bus	IO-5	PU 8k2 5V	-
86	SMEMW#	ISA System Memory Write	O-5	PU 8k2 5V	-
87	SD2	ISA Data Bus	IO-5	PU 8k2 5V	-
88	SD1	ISA Data Bus	IO-5	PU 8k2 5V	-
89	SD3	ISA Data Bus	IO-5	PU 8k2 5V	-
90	NOWS#	ISA No Wait Staits	I-5	PU 330R 5V	-
91	DREQ2	ISA DMA Request 2	I-5	PD 8k2	-
92	SD4	ISA Data Bus	IO-5	PU 8k2 5V	-
93	SD5	ISA Data Bus	IO-5	PU 8k2 5V	-
94	IRQ9	ISA Interrupt Request 9	I-5	PU 8k2 5V	-
95	SD6	ISA Data Bus	IO-5	PU 8k2 5V	-
96	SD7	ISA Data Bus	IO-5	PU 8k2 5V	-
97	IOCHK#	ISA I/O Channel Check	I-5	PU 8k2 5V	-
98	RSTDRV	ISA Reset	O-5	-	-
99	GND	Ground	PWR	-	-
100	GND	Ground	PWR	-	-



The termination resistors in this table are already mounted on the ETX® board. Please refer to the design guide for information about additional termination resistors.

6.3.2 Connector X3 (Signal Levels)

Pin	Signal	Description	Type	Termination	Comment
1	GND	Ground	PWR	-	-
2	GND	Ground	PWR	-	-
3	R	Analog Video Out RGB - Red Channel	0	-	-
4	B	Analog Video Out RGB - Blue Channel	0	-	-
5	HSY	Horizontal Synchronization Pulse	0-5	-	-
6	G	Analog Video Out RGB - Green Channel	0	-	-
7	VSX	Vertical Synchronization Pulse	0-5	-	-
8	DDCK	Display Data Channel Clock	IO-5	PU 2k2 5V	-
9	DETECT# / nc	Panel Hot-Plug Detection	nc	-	Not supported
10	DDDA	Display Data Channel Data	IO-5	PU 2k2 5V	-
11	LCDD016	LVDS Channel Data	0	-	-
12	LCDD018	LVDS Channel Data	0	-	-
13	LCDD017	LVDS Channel Data	0	-	-
14	LCDD019	LVDS Channel Data	0	-	-
15	GND	Ground	PWR	-	-
16	GND	Ground	PWR	-	-
17	LCDD013	LVDS Channel Data	0	-	-
18	LCDD015	LVDS Channel Data	0	-	-
19	LCDD012	LVDS Channel Data	0	-	-
20	LCDD014	LVDS Channel Data	0	-	-
21	GND	Ground	PWR	-	-
22	GND	Ground	PWR	-	-
23	LCDD08	LVDS Channel Data	0	-	-
24	LCDD011	LVDS Channel Data	0	-	-
25	LCDD09	LVDS Channel Data	0	-	-
26	LCDD010	LVDS Channel Data	0	-	-
27	GND	Ground	PWR	-	-
28	GND	Ground	PWR	-	-
29	LCDD04	LVDS Channel Data	0	-	-
30	LCDD07	LVDS Channel Data	0	-	-
31	LCDD05	LVDS Channel Data	0	-	-
32	LCDD06	LVDS Channel Data	0	-	-
33	GND	Ground	PWR	-	-
34	GND	Ground	PWR	-	-
35	LCDD01	LVDS Channel Data	0	-	-
36	LCDD03	LVDS Channel Data	0	-	-
37	LCDD00	LVDS Channel Data	0	-	-
38	LCDD02	LVDS Channel Data	0	-	-
39	VCC	Power +5V	PWR	-	-
40	VCC	Power +5V	PWR	-	-
41	JILI_DAT	JILI I2C Data Signal	IO-3,3	PU 2k2 3,3V	-
42	LTGIO0	PWM Brightness control for LCD	0-3,3	-	-
43	JILI_CLK	JILI I2C Clock Signal	IO-3,3	PU 2k2 3,3V	-
44	BLON#	Display Backlight On	0-3,3	-	-
45	BIASON	Display Contrast	0-3,3	PU 4k7 3,3V	Not supported
46	DIGON	Display Power On	0-3,3	-	-
47	COMP	Composite Video / SCART Blue	nc	-	Not supported
48	Y	S-Video Luminance / SCART Red	nc	-	Not supported
49	SYNC	-	nc	-	Not supported
50	C	S-Video Chrominance / SCART Green	nc	-	Not supported
51	LPT / FLPY#	LPT / Floppy Interface Configuration Input	I-3,3	PU 10k 3,3V	High: LPT, Low: Floppy
52	nc	-	nc	-	Reserved
53	VCC	Power +5V	PWR	-	-
54	GND	Ground	PWR	-	-
55	STB#	LPT Strobe Signal	0-3,3	-	-
56	AFD# / DENSEL	LPT Automatic Feed / Floppy Density Select	0-3,3	-	-
57	nc	-	nc	-	Reserved
58	PD7	LPT Data Bus D7	IO-3,3	-	-
59	IRRX	Infrared Receive	I-3,3	PU 100k 3,3V	-
60	ERR# / HDSEL#	LPT Error / Floppy Head Select	IO-3,3	-	-
61	IRTX	Infrared Transmit	0-3,3	-	-
62	PD6	LPT Data Bus D6	IO-3,3	-	-
63	RXD2	Data Receive COM2	I-3,3	PU 100k 5V	-
64	INIT# / DIR#	LPT Initiate / Floppy Direction	0-3,3	-	-

65	GND	Ground	PWR	-	-
66	GND	Ground	PWR	-	-
67	RTS2#	Request to Send COM2	0-3,3	PU 100k 3,3V	-
68	PD5	LPT Data Bus D5	IO-3,3	-	-
69	DTR2#	Data Terminal Ready COM2	0-3,3	PU 100k 3,3V	-
70	SLIN# / STEP#	LPT Select / Floppy Motor Step	0-3,3	-	-
71	DCD2#	Data Carrier Detect COM2	I-3,3	PU 4k7 5V	-
72	PD4 / DSKCHG#	LPT Data Bus D4 / Floppy Disk Change	IO-3,3	-	-
73	DSR2#	Data Set Ready COM2	I-3,3	PU 4k7 5V	-
74	PD3 / RDATA#	LPT Data Bus D3 / Floppy Raw Data Read	IO-3,3	-	-
75	CTS2#	Clear to Send COM2	I-3,3	PU 4k7 5V	-
76	PD2 / WP#	LPT Data Bus D2 / Floppy Write Protect Signal	IO-3,3	-	-
77	TXD2	Data Transmit COM2	0-3,3	-	Bootstrap PU 1k 3,3V
78	PD1 / TRK0#	LPT Data Bus D1 / Floppy Track Signal	IO-3,3	-	-
79	RI2#	Ring Indicator COM2	I-3,3	PU 4k7 5V	-
80	PD0 / INDEX#	LPT Data Bus D0 / Floppy Index Signal	IO-3,3	-	-
81	VCC	Power +5V	PWR	-	-
82	VCC	Power +5V	PWR	-	-
83	RXD1	Data Receive COM1	I-3,3	PU 100k 3,3V	5V tolerant
84	ACK# / DRV	LPT Acknowledge / Floppy Drive Select	IO-3,3	-	-
85	RTS1#	Request to Send COM1	0-3,3	-	Bootstrap PU 1k 3,3V
86	BUSY / MOT	LPT Busy / Floppy Motor Select	IO-3,3	-	-
87	DTR1#	Data Terminal Ready COM1	0-3,3	-	Bootstrap PU 1k 3,3V
88	PE / WDATA#	LPT Paper Empty / Floppy Raw Write Data	IO-3,3	-	-
89	DCD1#	Data Carrier Detect COM1	I-3,3	PU 100k 3,3V	-
90	SLCT#/WGATE#	LPT Power On / Floppy Write Enable	IO-3,3	-	-
91	DSR1#	Data Set Ready COM1	I-3,3	PU 100k 3,3V	-
92	MSCLK	Mouse Clock	I-3,3	PU 4k7 3,3V	-
93	CTS1#	Clear to Send COM1	I-3,3	PU 100k 3,3V	-
94	MSDAT	Mouse Data	I-3,3	PU 4k7 3,3V	-
95	TXD1	Data Transmit COM1	0-3,3	-	Bootstrap PU 1k 3,3V
96	KBCLK	Keyboard Clock	I-3,3	PU 4k7 3,3V	-
97	RI1#	Ring Indicator COM1	I-3,3	PU 100k 3,3V	-
98	KBDAT	Keyboard Data	I-3,3	PU 4k7 3,3V	-
99	GND	Ground	PWR	-	-
100	GND	Ground	PWR	-	-



The termination resistors in this table are already mounted on the ETX® board. Please refer to the design guide for information about additional termination resistors.



LPC, Mouse, Keyboard and COM signals are 5V tolerant.

6.4 Connector X4 Subsystems

6.4.1 Connector X4 (IDE 1, IDE 2, Ethernet, Miscellaneous)

Pin	Signal	Pin	Signal	Pin	Signal	Pin	Signal
1	GND	2	GND	51	SIDE_IOW# 2)	52	PIDE_IOR#
3	5V_SB	4	PWGIN	53	SIDE_DRQ 2)	54	PIDE_IOW#
5	PS_ON	6	SPEAKER	55	SIDE_D15 2)	56	PIDE_DRQ
7	PWRBTN#	8	BATT	57	SIDE_D0 2)	58	PIDE_D15
9	KBINH#	10	LILED#	59	SIDE_D14 2)	60	PIDE_D0
11	RSMRST#	12	ACTLED#	61	SIDE_D1 2)	62	PIDE_D14
13	ROMKBCS# 2)	14	SPEEDLED#	63	SIDE_D13 2)	64	PIDE_D1
15	EXT_PRG 2)	16	I2CLK	65	GND	66	GND
17	VCC 1)	18	VCC 1)	67	SIDE_D2 2)	68	PIDE_D13
19	OVCR#	20	GPCS# 2)	69	SIDE_D12 2)	70	PIDE_D2
21	EXTSMI#	22	I2DAT	71	SIDE_D3 2)	72	PIDE_D12
23	SMBCLK	24	SMBDATA	73	SIDE_D11 2)	74	PIDE_D3
25	SIDE_CS3# 2)	26	RESERVED	75	SIDE_D4 2)	76	PIDE_D11
27	SIDE_CS1# 2)	28	DASP_S 2)	77	SIDE_D10 2)	78	PIDE_D4
29	SIDE_A2 2)	30	PIDE_CS3#	79	SIDE_D5 2)	80	PIDE_D10
31	SIDE_A0 2)	32	PIDE_CS1#	81	VCC	82	VCC 1)
33	GND	34	GND	83	SIDE_D9 2)	84	PIDE_D5
35	PDIAG_S 2)	36	PIDE_A2	85	SIDE_D6 2)	86	PIDE_D9
37	SIDE_A1 2)	38	PIDE_A0	87	SIDE_D8 2)	88	PIDE_D6
39	SIDE_INTRQ 2)	40	PIDE_A1	89	RESERVED	90	RESERVED
41	RESERVED	42	RESERVED	91	RXD#	92	PIDE_D8
43	SIDE_AK# 2)	44	PIDE_INTRQ	93	RXD	94	SIDE_D7
45	SIDE_RDY 2)	46	PIDE_AK#	95	TXD#	96	PIDE_D7
47	SIDE_IOR# 2)	48	PIDE_RDY	97	TXD	98	HDRST#
49	VCC 1)	50	VCC 1)	99	GND	100	GND

6.4.2 Connector X4 (Signal Levels)

Pin	Signal	Description	Type	Termination	Comment
1	GND	Ground	PWR	-	-
2	GND	Ground	PWR	-	-
3	5V_SB	Supply of internal suspend Circuit	PWR	-	-
4	PWGIN	Power Good / Reset Input	I-3,3	PU 4k7 3,3V_SB	5V tolerant
5	PS_ON	Power Supply On	O-5	PU 4k7 5V	-
6	SPEAKER	Speaker Output	O-3,3	-	-
7	PWRBTN#	Power Button	I-5	PU 5k 5V	-
8	BATT	Battery Supply	PWR	-	-
9	KBINH	Keyboard Inhibit Control Input	nc	-	Not supported
10	L1LED	Ethernet Link LED	O	-	Open collector
11	RSMRST#	Resume Reset	I-3,3	PU 4k7 3,3V	5V tolerant
12	ACTLED	Ethernet Activity LED	O	-	Open collector
13	ROMKBCS#	-	O-5	PU 10k 5V	Not supported
14	SPEEDLED	Ethernet Speed LED	O	-	Open collector
15	EXT_PRG	-	nc	-	Not supported
16	I2CLK	I2C Bus Clock	O-5	PU 2k2 5V	-
17	VCC	Power +5V	PWR	-	-
18	VCC	Power +5V	PWR	-	-
19	OVCR#	Over Current Detect for USB	I-3,3	PU 10k 3,3V	-
20	GPCS#	-	O-5	PU 10k 5V	Not supported
21	EXTSMI#	System Management Interrupt Input	I-3,3	PU 4k7 3,3V	5V tolerant
22	I2DAT	I2C Bus Data	IO-5	PU 2k2 5V	-
23	SMBCLK	SM Bus Clock	O-3,3	PU 2k2 3,3V	-
24	SMBDATA	SM Bus Data	IO-3,3	PU 2k2 3,3V	-
25	SIDE_CS3#	Secondary IDE Chip Select Channel 1	O-3,3	-	-
26	SMBALRT#	SMB Alert	I-3,3	PU 2k2 3,3V	-
27	SIDE_CS1#	Secondary IDE Chip Select Channel 1	O-3,3	-	-
28	DASP_S	-	nc	-	Not supported
29	SIDE_A2	Secondary IDE Adress Bus	O-3,3	-	-
30	PIDE_CS3#	Primary IDE Chip Select Channel 1	O-3,3	-	-
31	SIDE_A0	Secondary IDE Adress Bus	O-3,3	-	-
32	PIDE_CS1#	Primary IDE Chip Select Channel 0	O-3,3	-	-
33	GND	Ground	PWR	-	-
34	GND	Ground	PWR	-	-
35	PDIAG_S	Secondary IDE CBLID#	I-3,3	PD 100k	-
36	PIDE_A2	Primary IDE Adress Bus	O-3,3	-	-
37	SIDE_A1	Secondary IDE Adress Bus	O-3,3	-	-
38	PIDE_A0	Primary IDE Adress Bus	O-3,3	-	-
39	SIDE_INTRQ	Secondary IDE Interrupt Reqeuest	I-3,3	PD 10k	-
40	PIDE_A1	Primary IDE Adress Bus	O-3,3	-	-
41	BATLOW#	Battery Low	I-3,3	PU 4k7 3,3V	5V tolerant
42	GPE1#	General Purpose Power Event 1	I-3,3	-	5V tolerant, pin GEVENT5# with int. PU 8k2 in A55E
43	SIDE_AK#	Secondary IDE DMA Acknowledge	O-3,3	-	-
44	PIDE_INTRQ	Primary IDE Interrupt Reqeuest	I-3,3	PD 10k	-
45	SIDE_RDY	Secondary IDE Ready	I-3,3	PU 4k7 3,3V	-
46	PIDE_AK#	Primary IDE DMA Acknowledge	O-3,3	-	-
47	SIDE_IOR#	Secondary IDE IO Read	O-3,3	-	-
48	PIDE_RDY	Primary IDE Ready	I-3,3	PU 4k7 3,3V	-
49	VCC	Power +5V	PWR	-	-
50	VCC	Power +5V	PWR	-	-
51	SIDE_IOW#	Secondary IDE IO Write	O-3,3	-	-
52	PIDE_IOR#	Primary IDE IO Read	O-3,3	-	-
53	SIDE_DRQ	Secondary IDE DMA Request	I-3,3	PD 5k6	-
54	PIDE_IOW#	Primary IDE IO Write	O-3,3	-	-
55	SIDE_D15	Secondary IDE Data Bus	IO-3,3	-	-
56	PIDE_DRQ	Primary IDE DMA Request	I-3,3	PD 5k6	-
57	SIDE_D0	Secondary IDE Data Bus	IO-3,3	-	-
58	PIDE_D15	Primary IDE Data Bus	IO-3,3	-	-
59	SIDE_D14	Secondary IDE Data Bus	IO-3,3	-	-
60	PIDE_D0	Primary IDE Data Bus	IO-3,3	-	-
61	SIDE_D1	Secondary IDE Data Bus	IO-3,3	-	-
62	PIDE_D14	Primary IDE Data Bus	IO-3,3	-	-
63	SIDE_D13	Secondary IDE Data Bus	IO-3,3	-	-
64	PIDE_D1	Primary IDE Data Bus	IO-3,3	-	-

65	GND	Ground	PWR	-	-
66	GND	Ground	PWR	-	-
67	SIDE_D2	Secondary IDE Data Bus	IO-3,3	-	-
68	PIDE_D13	Primary IDE Data Bus	IO-3,3	-	-
69	SIDE_D12	Secondary IDE Data Bus	IO-3,3	-	-
70	PIDE_D2	Primary IDE Data Bus	IO-3,3	-	-
71	SIDE_D3	Secondary IDE Data Bus	IO-3,3	-	-
72	PIDE_D12	Primary IDE Data Bus	IO-3,3	-	-
73	SIDE_D11	Secondary IDE Data Bus	IO-3,3	-	-
74	PIDE_D3	Primary IDE Data Bus	IO-3,3	-	-
75	SIDE_D4	Secondary IDE Data Bus	IO-3,3	-	-
76	PIDE_D11	Primary IDE Data Bus	IO-3,3	-	-
77	SIDE_D10	Secondary IDE Data Bus	IO-3,3	-	-
78	PIDE_D4	Primary IDE Data Bus	IO-3,3	-	-
79	SIDE_D5	Secondary IDE Data Bus	IO-3,3	-	-
80	PIDE_D10	Primary IDE Data Bus	IO-3,3	-	-
81	VCC	Power +5V	PWR	-	-
82	VCC	Power +5V	PWR	-	-
83	SIDE_D9	Secondary IDE Data Bus	IO-3,3	-	-
84	PIDE_D5	Primary IDE Data Bus	IO-3,3	-	-
85	SIDE_D6	Secondary IDE Data Bus	IO-3,3	-	-
86	PIDE_D9	Primary IDE Data Bus	IO-3,3	-	-
87	SIDE_D8	Secondary IDE Data Bus	IO-3,3	-	-
88	PIDE_D6	Primary IDE Data Bus	IO-3,3	-	-
89	GPE2#	General Purpose Power Event 1	I-3,3	-	5V tolerant, pin RI# with int. PU 8k2 in A55E
90	CBLID_P#	Primary IDE CBLID#	I-3,3	PD 100k	-
91	RXD#	Ethernet Receive Differential Signal (RXD-)	I	-	-
92	PIDE_D8	Primary IDE Data Bus	IO-3,3	-	-
93	RXD	Ethernet Receive Differential Signal (RXD+)	I	-	-
94	SIDE_D7	Secondary IDE Data Bus	IO-3,3	-	int. PD in JMB368
95	TXD#	Ethernet Transmit Differential Signal (TXD-)	0	-	-
96	PIDE_D7	Primary IDE Data Bus	IO-3,3	-	int. PD in JMB368
97	TXD	Ethernet Transmit Differential Signal (TXD+)	0	-	-
98	HDRST#	Hard Drive Reset	O-3,3	-	-
99	GND	Ground	PWR	-	-
100	GND	Ground	PWR	-	-



The termination resistors in this table are already mounted on the ETX® board. Please refer to the design guide for information about additional termination resistors.

7 BIOS Operation

The module is equipped with AMI® Aptio, which is located in an onboard SPI serial flash memory.

7.1 Determining the BIOS Version

The AMI® Aptio version is displayed in the main menu of the setup utility.

- » BIOS Vendor: American Megatrends
- » Core Version: x.x.x.x
- » BIOS Date: mm/dd/yyyy hh:mm:ss
- » BIOS Version: MBR1RXXX

7.2 BIOS Update

Kontron provides continuous BIOS updates for Computer-on-Modules. The updates are provided for download on <http://emdcustomersection.kontron.com> with a detailed change description within the according Product Change Notification (PCN). Please register for EMD Customer Section to get access to BIOS downloads and PCN service.

Modules with BIOS Region/Setup only inside the flash can be updated with AFU utilities (usually 1-3MB BIOS binary file size) directly. Modules with Intel® Management Engine, Ethernet, Flash Descriptor and other options additionally to the BIOS Region (usually 4-8MB BIOS binary file size) requires a different update process with Intel Flash Utility FPT and a wrapper to backup and restore configurations and the MAC address. Therefore it is strongly recommended to use the batch file inside the BIOS download package available on EMD Customer Section.

» Boot the module to DOS/EFI Shell with access to the BIOS image and Firmware Update Utility provided on EMD Customer Section

- » Execute Flash.bat in DOS or Flash.nsh in EFI Shell



Any modification of the update process may damage your module!

Backup the BIOS / Create a BIOS with custom defaults:

- » Change your BIOS settings according your needs
- » Save and Exit Setup with option "Save as User Defaults". Your customized settings are now stored inside the flash in a second area additional to the manufacturer defaults
- » Boot the module to DOS or EFI Shell with access to the update utilities
- » Extract the BIOS region including your custom defaults with **afuefix64.efi CBIOS.bin /0** in EFI Shell or **afudos.exe CBIOS.rom /0** in DOS

Now you can clone the BIOS with your customized default settings to other modules or external SPI flashes with above mention AFU utilites. On modules with Management Engine and Ethernet inside the Flash the same BIOS core version should already be programmed on the target.



AMI APTIO update utilities for DOS, EFI Shell and Windows are available for free at AMI.com:
<http://www.ami.com/support/downloads/amiflash.zip>

7.3 Setup Guide

The Aptio Setup Utility changes system behavior by modifying the Firmware configuration. The setup program uses a number of menus to make changes and turn features on or off.

Functional keystrokes in POST:

Key	Function
DEL	Enter Setup
F2	Enter Setup
F7	Boot Menu

7.4 POST Codes

Important POST codes during boot-up

AB	BIOS Setup
AD	EFI Shell
AE	Windows

7.4.1 Start AMI® Aptio Setup Utility

To start the AMI® BIOS setup utility, press or <F2> when the following string appears during bootup.

Press to enter Setup

The Info Menu then appears.

The Setup Screen is composed of several sections:

Setup Screen	Location	Function
Menu Bar	Top	Lists and selects all top level menus.
Legend Bar	Right side Bottom	Lists setup navigation keys.
Item Specific Help Window	Right side Top	Help for selected item.
Menu Window	Left Center	Selection fields for current menu.

Menu Bar

The menu bar at the top of the window lists different menus. Use the left/right arrow keys to make a selection.

Legend Bar

Use the keys listed in the legend bar on the bottom to make your selections or exit the current menu. The table below describes the legend keys and their alternates.

Key	Function
← or → Arrow key	Select a menu.
↑ or ↓ Arrow key	Select fields in current menu.
<Home> or <End>	Move cursor to top or bottom of current window.
<PgUp> or <PgDn>	Move cursor to next or previous page.
+/-	Change Option
<Enter>	Execute command or select submenu.
<F1>	General Help window.
<F2>	Previous Values
<F3>	Load the optimized default configuration.
<F4>	Save and exit.
<Esc>	Exit menu.

Selecting an Item

Use the ↑ or ↓ key to move the cursor to the field you want. Then use the + and – keys to select a value for that field. The Save Value commands in the Exit menu save the values displayed in all the menus.

Displaying Submenus

Use the ← or → key to move the cursor to the submenu you want. Then press <Enter>. A pointer (▶) marks all submenus.

Item Specific Help Window

The Help window on the right side of each menu displays the Help text for the selected item. It updates as you move the cursor to each field.

General Help Window

Pressing <F1> on a menu brings up the General Help window that describes the legend keys and their alternates. Press <Esc> to exit the General Help window.

7.5 BIOS Setup

7.5.1 Main

```

Aptio Setup Utility - Copyright (C) 2012 American Megatrends, Inc.
Main Advanced Chipset Boot Security Save & Exit

BIOS Information
BIOS Vendor      American Megatrends
Core Version     4.6.5.4
Compliancy      UEFI 2.3.1; PI 1.2
Project Version  MBR1R112 x64
Build Date and Time 04/24/2014 07:20:00

Memory Information
Total Memory     2032 MB (DDR3)

▶ Platform Information

System Language  [English]

System Date     [Thu 04/24/2014]
System Time     [11:28:30]

Access Level    Administrator

Platform Information
><: Select Screen
↓: Select Item
Enter: Select
+/-: Change Opt.
F1: General Help
F2: Previous Values
F3: Optimized Defaults
F4: Save & Exit
ESC: Exit

Version 2.15.1236. Copyright (C) 2012 American Megatrends, Inc.

```

Feature	Options	Description
System Language	English	Choose the system default language. English supported only
System Date	[mm/dd/yyyy]	Set the Date. Use 'Tab' to switch between Date elements
System Time	[hh:mm:ss]	Set the Time. Use 'Tab' to switch between Time elements

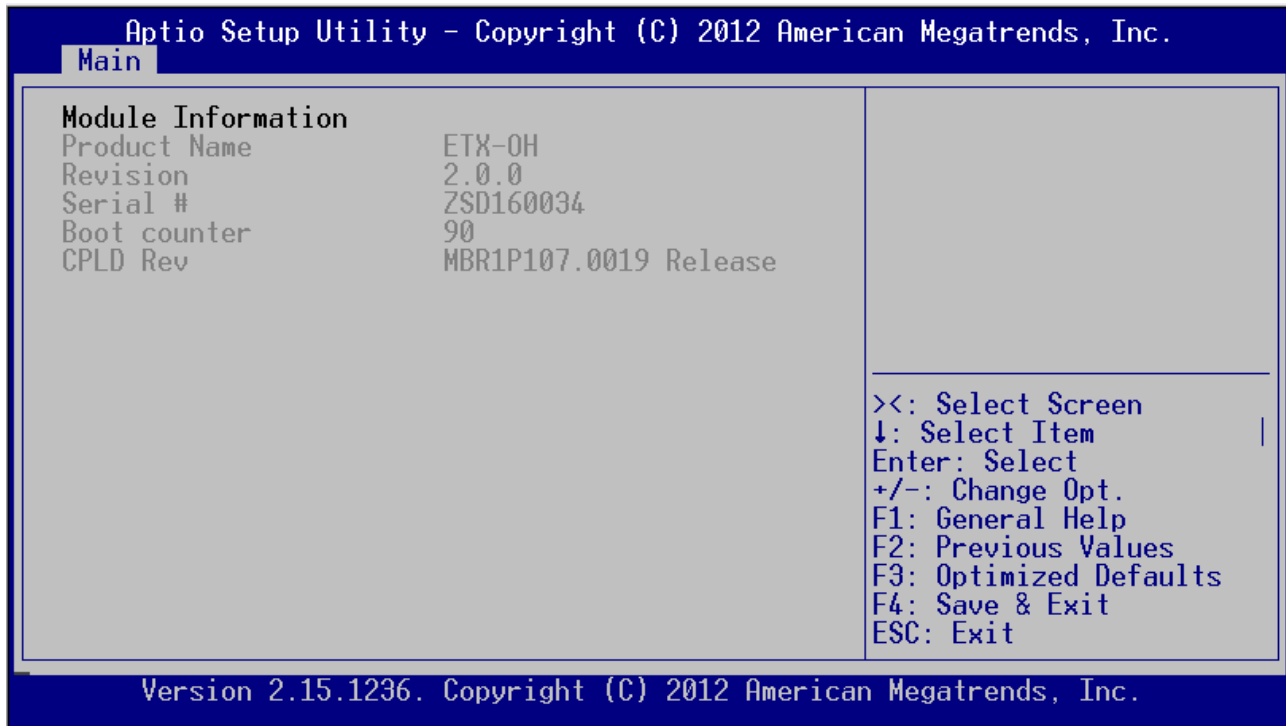

7.5.2 Advanced

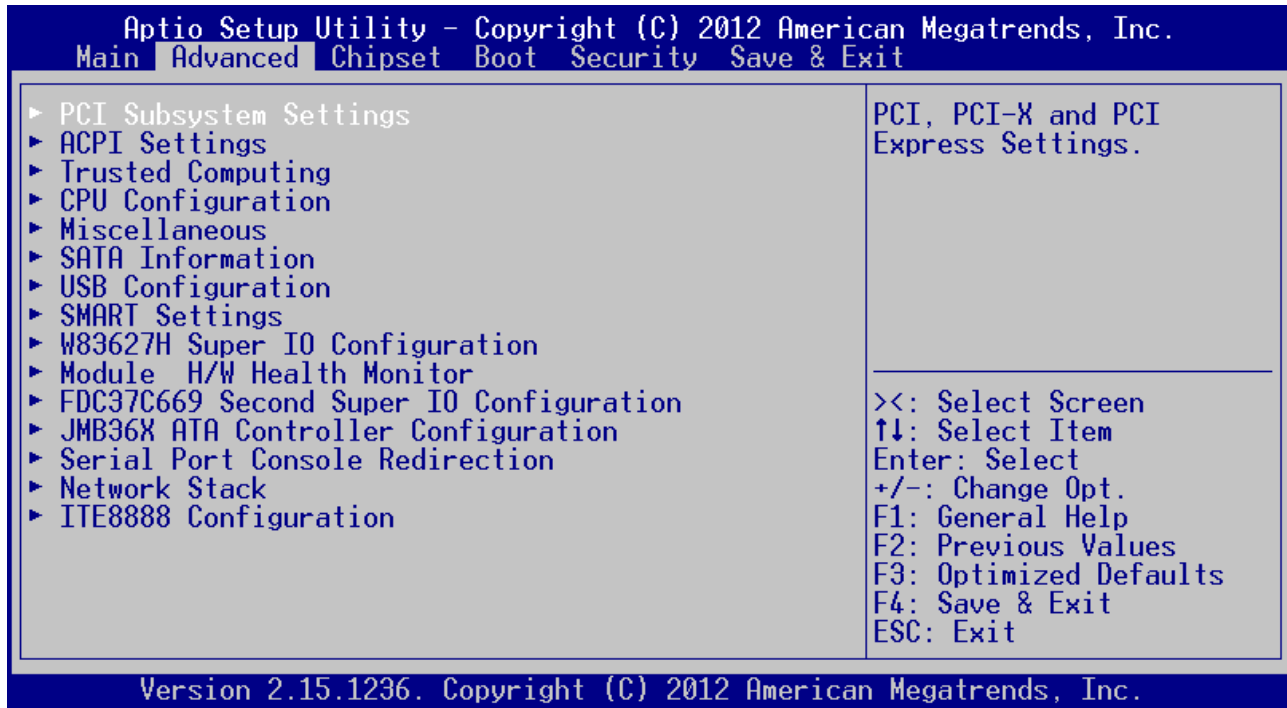

PCI Subsystem Settings

Aptio Setup Utility - Copyright (C) 2012 American Megatrends, Inc.

Advanced

PCI Bus Driver Versio V 2.05.02 PCI Common Settings PCI Latency Timer [32 PCI Bus Clocks] VGA Palette Snoop [Disabled] PERR# Generation [Disabled] SERR# Generation [Disabled]	Value to be programmed into PCI Latency Timer Register. ><: Select Screen ↑↓: Select Item Enter: Select +/-: Change Opt. F1: General Help F2: Previous Values F3: Optimized Defaults F4: Save & Exit ESC: Exit
---	---

Version 2.15.1236. Copyright (C) 2012 American Megatrends, Inc.

Feature	Options	Description
PCI Latency Timer	32 ... 248 PCI Bus Clocks	Value to be programmed into PCI Latency Timer Register
VGA Palette Snoop	Disabled Enabled	Enables or Disables VGA Palette Registers Snooping
PERR# Generation	Disabled Enabled	Enables or Disables PCI Device to Generate PERR#
SERR# Generation	Disabled Enabled	

ACPI Settings

Aptio Setup Utility - Copyright (C) 2012 American Megatrends, Inc.

Advanced

<p>ACPI Settings</p> <p>Enable ACPI Auto Conf [Disabled]</p> <p>Enable Hibernation [Enabled]</p> <p>ACPI Sleep State [S3 only(Suspend to ...)]</p> <p>Lock Legacy Resources [Disabled]</p> <p>S3 Video Repost [Disabled]</p> <p>Critical Trip Point [110]</p>	<p>Enables or Disables BIOS ACPI Auto Configuration.</p> <hr/> <p>><: Select Screen ↑↓: Select Item Enter: Select +/-: Change Opt. F1: General Help F2: Previous Values F3: Optimized Defaults F4: Save & Exit ESC: Exit</p>
---	--

Version 2.15.1236. Copyright (C) 2012 American Megatrends, Inc.

Feature	Options	Description
Enable ACPI Auto Configuration	Disabled Enabled	Enables or Disables BIOS ACPI Auto Configuration
Enable Hibernation	Disabled Enabled	Enables or Disables System ability to Hibernate (OS/S4 Sleep State)
ACPI Sleep State	Suspend Disabled S3 only (StR)	Select the highest ACPI sleep state the system will enter when the SUSPEND button is pressed
Lock Legacy Resources	Disabled Enabled	Enables or Disables Lock of Legacy Resources
S3 Video Repost	Disabled Enabled	Enable or Disable S3 Video Repost
Critical Trip Point	Disabled 60 ... 110	The Celsius Temperature of the ACPI Critical Trip Point. At his Temperature, the ACPI OS shuts the system off

Trusted Computing

Aptio Setup Utility - Copyright (C) 2012 American Megatrends, Inc.

Advanced

<p>Configuration TPM SUPPORT [Disable]</p> <p>Current Status Information NO Security Device</p>	<p>Enables or Disables BIOS support for security device. O.S. will not show Security Device. TCG EFI protocol and INT1A interface will not be available.</p> <hr/> <p>><: Select Screen ↑↓: Select Item Enter: Select +/-: Change Opt. F1: General Help F2: Previous Values F3: Optimized Defaults F4: Save & Exit ESC: Exit</p>
---	--

Version 2.15.1223. Copyright (C) 2012 American Megatrends, Inc.

Feature	Options	Description
TPM Support	Disable Enable	Enables or Disables BIOS support for security device. O.S. will not show Security Device. TCG EFI protocol and INT1A interface will not be available
TPM State	Disabled Enabled	Enable/Disable Security Device. Note: Your Computer will reboot during restart in order to change State of the Device
Pending Operation	None Enable Take Ownership Disable Take Ownership TPM Clear	Schedule an Operation for the Security Device. Note: Your Computer will reboot during restart in order to change State of the Device

CPU Configuration

Aptio Setup Utility - Copyright (C) 2012 American Megatrends, Inc.

Advanced

<p>CPU Configuration</p> <p>Module Version: 4.6.3.7 OntarioPI 031 AGESA Version : 1.2.0.1</p> <p>PSS Support [Enabled] PSTATE Adjustment [PState 0] PPC Adjustment [PState 0] NX Mode [Enabled] SVM Mode [Enabled] C6 Mode [Enabled] Core Performance Boos [Disabled]</p> <p>Hardware Thermal Control PSTATE (degraded) [Default] HTC Temp. Limit [Default] HTC Lock [Enabled]</p> <p>▶ Node 0 Information</p>	<p>Enable/disable the generation of ACPI _PPC, _PSS, and _PCT objects.</p> <hr/> <p>><: Select Screen ↑↓: Select Item Enter: Select +/-: Change Opt. F1: General Help F2: Previous Values F3: Optimized Defaults F4: Save & Exit ESC: Exit</p>
---	--

Version 2.15.1236. Copyright (C) 2012 American Megatrends, Inc.

Feature	Options	Description
PSS Support	Disable Link Enabled	Enable/disable the generation of ACPI _PPC, _PSS and _PCT objects
PSTATE Adjustment	PState 0 PState 1 PState 2	Provide to adjust startup P-state level
PPC Adjustment	PState 0 PState 1 PState 2	Provide to adjust _PPC object
NX Mode	Disable Link Enabled	Enable/disable No-execute page protection Function
SVM Mode	Disable Link Enabled	Enable/disable CPU Virtualization
C6 Mode	Disable Link Enabled Auto	Enable/disable C6
Core Performance Boost	Disabled Auto	Enable/disable CPB
PSTATE (degraded)	PState 0 PState 1 PState 2 Default	Select degraded P-state when HTC is active
HTC Temp. Limit	100 ... 60 Default	Select HTC temperature limit (degree Celsius)
HTC Lock	Disabled Enabled	Select whether HTC register shall be locked (read only)

Node 0 Information

```

Aptio Setup Utility - Copyright (C) 2012 American Megatrends, Inc.
  Advanced
Node0: AMD G-T56N Processor
Dual Core Running @ 1666 MHz 1350 mV
Max Speed:1650 MHZ   Intended Speed:1650 MHZ
Min Speed:825 MHZ
Microcode Patch Level: 500010d

----- Cache per Core -----
L1 Instruction Cache: 32 KB/8-way
      L1 Data Cache: 32 KB/2-way
      L2 Cache: 512 KB/16-way
No L3 Cache Present

><: Select Screen
↑↓: Select Item
Enter: Select
+/-: Change Opt.
F1: General Help
F2: Previous Values
F3: Optimized Defaults
F4: Save & Exit
ESC: Exit

Version 2.15.1223. Copyright (C) 2012 American Megatrends, Inc.

```

Miscellaneous

Aptio Setup Utility - Copyright (C) 2012 American Megatrends, Inc.

Advanced

<p>Miscellaneous Configuration</p> <ul style="list-style-type: none"> ▶ Watchdog ▶ Smart Battery Configuration <p>Restore on AC Power L [Power On] SB Clock Spread Spect [Disabled]</p>	<p>Watchdog Configuration.</p> <hr/> <p>><: Select Screen ↑↓: Select Item Enter: Select +/-: Change Opt. F1: General Help F2: Previous Values F3: Optimized Defaults F4: Save & Exit ESC: Exit</p>
---	--

Version 2.15.1236. Copyright (C) 2012 American Megatrends, Inc.

Feature	Options	Description
Restore on AC Power Loss	Disabled Power On Power Off Last State	Select the module behavior after AC Power Loss
SB Clock Spread Spect	Disabled Enabled	Enable or Disable Spread Spectrum

Watchdog

Aptio Setup Utility - Copyright (C) 2012 American Megatrends, Inc.

Advanced

<p>Watchdog Configuration.</p> <p>Auto-reload [Disabled]</p> <p>Global Lock [Disabled]</p> <p>Stage 1 Mode [Disabled]</p>	<p>Enable automatic reload of watchdog timers on timeout.</p> <hr/> <p>><: Select Screen ↑↓: Select Item Enter: Select +/-: Change Opt. F1: General Help F2: Previous Values F3: Optimized Defaults F4: Save & Exit ESC: Exit</p>
---	---

Version 2.15.1223. Copyright (C) 2012 American Megatrends, Inc.

Feature	Options	Description
Auto-reload	Disabled Enabled	Enable automatic reload of watchdog timers on timeout
Global Lock	Disabled Enabled	If set to enabled, all Watchdog registers (except WD_KICK) become read only until the board is reset
Stage 1 Mode	Disabled Reset NMI SCI	Select Watchdog Action
Stage 1 Timeout	1s 5s 10s 30s 1m 3m 10m 30m	Select Watchdog Timeout value

Smart Battery Configuration

Aptio Setup Utility - Copyright (C) 2012 American Megatrends, Inc.

Advanced

<p>Smart Battery Configuration</p> <p>M.A.R.S. [Auto] System Type : N/A Power Source : Unknown Connected Batteries : 0</p> <ul style="list-style-type: none"> ▶ Battery #1 (slot empty) ▶ Battery #2 (slot empty) ▶ Battery #3 (slot empty) ▶ Battery #4 (slot empty) 	<p>Preset M.A.R.S. Smart Battery System mode. System must be restarted to reflect mode changes.</p> <hr/> <p>><: Select Screen ↑↓: Select Item Enter: Select +/-: Change Opt. F1: General Help F2: Previous Values F3: Optimized Defaults F4: Save & Exit ESC: Exit</p>
---	---

Version 2.15.1223. Copyright (C) 2012 American Megatrends, Inc.

Feature	Options	Description
M.A.R.S.	Disabled AUTO Charger Manager	Preset M.A.R.S. Smart Battery System mode. System must be restarted to reflect mode changes

Battery Information

Aptio Setup Utility - Copyright (C) 2012 American Megatrends, Inc.

Advanced

Battery #1 (slot empty)	
State	: N/A
Manufacturer	: N/A
Serial Number	: N/A
Device Name	: N/A
Chemistry	: N/A
Rel. State of Charge	: N/A
Cycle Count	: N/A
Date Of Manufacturing	: N/A
Charge Time	: N/A
Discharge Time	: N/A
Temperature	: N/A
Device Capacity	: N/A
Last Full Capacity	: N/A
Battery Voltage	: N/A
Current On Terminals	: N/A

><: Select Screen
 ↑↓: Select Item
 Enter: Select
 +/-: Change Opt.
 F1: General Help
 F2: Previous Values
 F3: Optimized Defaults
 F4: Save & Exit
 ESC: Exit

Version 2.15.1223. Copyright (C) 2012 American Megatrends, Inc.

SATA Information

Aptio Setup Utility - Copyright (C) 2012 American Megatrends, Inc.

Advanced

SATA Information	
SATA Port0	Not Present
SATA Port1	Not Present
SATA Port4	Not Present

><: Select Screen
 ↑↓: Select Item
 Enter: Select
 +/-: Change Opt.
 F1: General Help
 F2: Previous Values
 F3: Optimized Defaults
 F4: Save & Exit
 ESC: Exit

Version 2.15.1236. Copyright (C) 2012 American Megatrends, Inc.

Feature	Options	Description
SATA Port 0 SATA Port 1 SATA Port 2	-	Shows the present devices on SATA0/1 = onboard SATA Ports and SATA4 = optional SSD Flashdrive

USB Configuration

Aptio Setup Utility - Copyright (C) 2012 American Megatrends, Inc.

Advanced

<p>USB Configuration</p> <p>USB Devices: 1 Drive, 1 Keyboard, 1 Mouse</p> <p>Legacy USB Support [Enabled] USB 2.0 Controller Mo [HiSpeed] EHCI Hand-off [Disabled] USB Mass Storage Driv [Enabled]</p> <p>USB hardware delays a USB transfer time-out [20 sec] Device reset time-out [20 sec] Device power-up delay [Auto]</p> <p>Mass Storage Devices: JetFlashTranscend 32G [Auto]</p>	<p>Enables Legacy USB support. AUTO option disables legacy support if no USB devices are connected. DISABLE option will keep USB devices available only for EFI applications.</p> <hr/> <p>><: Select Screen ↑↓: Select Item Enter: Select +/-: Change Opt. F1: General Help F2: Previous Values F3: Optimized Defaults F4: Save & Exit ESC: Exit</p>
--	---

Version 2.15.1236. Copyright (C) 2012 American Megatrends, Inc.

Feature	Options	Description
Legacy USB Support	Enabled Disabled AUTO	Enables Legacy USB support. AUTO option disables legacy support if no USB devices are connected. DISABLE option will keep USB devices available only for EFI applications.
USB 2.0 Controller Mode	HiSpeed FullSpeed	Configures the USB 2.0 controller in HiSpeed (480Mbps) or FullSpeed (12Mbps)
EHCI Hand-off	Disabled Enabled	This is a workaround for OSes without EHCI hand-off Support. The EHCI ownership change should be claimed by EHCI driver
USB Mass Storage Driver	Disabled Enabled	Enable/Disable USB Mass Storage Driver Support
USB transfer time-out	1sec 5sec 10sec 20sec	The time-out value for Control, Bulk and Interrupt transfers
Device reset time-out	10sec 20sec 30sec 40sec	USB mass storage device Start Unit command time-out
Device power-up delay	AUTO Manual	Maximum time the device will take before it properly reports itself to the Host controller. 'AUTO' uses default value: for a Root port it is 100ms, for a Hub port the delay is taken from Hub descriptor
Mass Storage Devices	AUTO Floppy Forced FDD Hard Disk CD-ROM	Mass storage device emulation type

SMART Settings

Aptio Setup Utility - Copyright (C) 2012 American Megatrends, Inc.

Advanced

SMART Settings	Run SMART Self Test on all HDDs during POST.
SMART Self Test [Disabled]	
	><: Select Screen ↑↓: Select Item Enter: Select +/-: Change Opt. F1: General Help F2: Previous Values F3: Optimized Defaults F4: Save & Exit ESC: Exit

Version 2.15.1236. Copyright (C) 2012 American Megatrends, Inc.

Feature	Options	Description
SMART Self Test	Disabled Enabled	Run SMART Self Test on all HDDs during Post

W83627H Super IO Configuration

Aptio Setup Utility - Copyright (C) 2012 American Megatrends, Inc.
Advanced

<p>W83627H Super IO Configuration</p> <p>W83627H Super IO Chip W83627H</p> <ul style="list-style-type: none"> ▶ Floppy Disk Controller Configuration ▶ Serial Port 0 Configuration ▶ Serial Port 1 Configuration ▶ Parallel Port Configuration 	<p>Set Parameters of Floppy Disk Controller (FDC)</p> <hr/> <p>><: Select Screen ↑↓: Select Item Enter: Select +/-: Change Opt. F1: General Help F2: Previous Values F3: Optimized Defaults F4: Save & Exit ESC: Exit</p>
--	---

Version 2.15.1223. Copyright (C) 2012 American Megatrends, Inc.

Floppy Disk Controller Configuration

Aptio Setup Utility - Copyright (C) 2012 American Megatrends, Inc.
Advanced

<p>Floppy Disk Controller Configuration</p> <p>Floppy Disk Controller [Enabled] Device Settings Reset Required</p> <p>Change Settings [Auto]</p>	<p>Enable or Disable Floppy Disk Controller. Attention: with ETX Modules you can either select the onboard floppy disk or parallel port with the corresponding hardware strap because they</p> <hr/> <p>><: Select Screen ↑↓: Select Item Enter: Select +/-: Change Opt. F1: General Help F2: Previous Values F3: Optimized Defaults F4: Save & Exit ESC: Exit</p>
--	--

Version 2.15.1223. Copyright (C) 2012 American Megatrends, Inc.

Feature	Options	Description
Floppy Disk Controller	Enabled Disabled	Enable or Disable Floppy Disk Controller. Attention: with ETX Modules you can either select the onboard floppy disk or parallel port with the corresponding hardware strap
Change Settings	Auto IO=3F0h;IRQ=6;DMA=2;	Select an optimal setting for Super IO device

Serial Port 0 Configuration

Aptio Setup Utility - Copyright (C) 2012 American Megatrends, Inc.
Advanced

<p>Serial Port 0 Configuration</p> <p>Serial Port [Enabled] Device Settings IO=3F8h; IRQ=4;</p> <p>Change Settings [Auto]</p>	<p>Enable or Disable Serial Port (COM)</p> <hr/> <p>><: Select Screen ↑↓: Select Item Enter: Select +/-: Change Opt. F1: General Help F2: Previous Values F3: Optimized Defaults F4: Save & Exit ESC: Exit</p>
--	--

Version 2.15.1223. Copyright (C) 2012 American Megatrends, Inc.

Feature	Options	Description
Serial Port	Enabled Disabled	Enable or Disable Serial Port (COM)
Change Settings	Auto IO=3F8h; IRQ=4 IO=3F8h; IRQ=3,4,5,6,7,9,10,11,12 IO=2F8h; IRQ=3,4,5,6,7,9,10,11,12 IO=3E8h; IRQ=3,4,5,6,7,9,10,11,12 IO=2E8h; IRQ=3,4,5,6,7,9,10,11,12	Select an optimal setting for Super IO device

Serial Port 1 Configuration

Aptio Setup Utility - Copyright (C) 2012 American Megatrends, Inc.

Advanced

<p>Serial Port 1 Configuration</p> <p>Serial Port [Enabled] Device Settings IO=2F8h; IRQ=3;</p> <p>Change Settings [Auto] Device Mode [Standard Serial Por...]</p>	<p>Enable or Disable Serial Port (COM)</p> <hr/> <p>><: Select Screen ↑↓: Select Item Enter: Select +/-: Change Opt. F1: General Help F2: Previous Values F3: Optimized Defaults F4: Save & Exit ESC: Exit</p>
---	--

Version 2.15.1223. Copyright (C) 2012 American Megatrends, Inc.

Feature	Options	Description
Serial Port	Enabled Disabled	Enable or Disable Serial Port (COM)
Change Settings	Auto IO=2F8h; IRQ=3 IO=3F8h; IRQ=3,4,5,6,7,9,10,11,12 IO=2F8h; IRQ=3,4,5,6,7,9,10,11,12 IO=3E8h; IRQ=3,4,5,6,7,9,10,11,12 IO=2E8h; IRQ=3,4,5,6,7,9,10,11,12	Select an optimal setting for Super IO device
Device Mode	Standard Serial Port Mode IrDA 1.0 (HP SIR) Mode ASKIR Mode	Change the Serial Port mode

Parallel Port Configuration

Aptio Setup Utility - Copyright (C) 2012 American Megatrends, Inc.
Advanced

Parallel Port Configuration		Enable or Disable Parallel Port (LPT/LPTE). Attention: with ETX Modules you can either select the onboard floppy disk or parallel port with the corresponding hardware strap because they ><: Select Screen ↑↓: Select Item Enter: Select +/-: Change Opt. F1: General Help F2: Previous Values F3: Optimized Defaults F4: Save & Exit ESC: Exit
Parallel Port Device Settings	[Enabled] IO=378h; IRQ=7;	
Change Settings Device Mode	[Auto] [STD Printer Mode]	

Version 2.15.1236. Copyright (C) 2012 American Megatrends, Inc.

Feature	Options	Description
Parallel Port	Enabled Disabled	Enable or Disable Parallel Port (LPT/LPTE). Attention: with ETX Modules you can either select the onboard floppy disk or parallel port with the corresponding hardware strap
Change Settings	Auto IO=378h; IRQ=7 IO=378h; IRQ=6,7,9,10,11,12 IO=278h; IRQ=6,7,9,10,11,12 IO=3BCh; IRQ=6,7,9,10,11,12	Select an optimal setting for Super IO device
Device Mode	Standard Printer Mode EPP Mode ECP Mode EPP Mode & ECP Mode	Change the Parallel Port mode

Module H/W Health Monitor

```

Aptio Setup Utility - Copyright (C) 2012 American Megatrends, Inc.
  Advanced
Pc Health Status
CPUVCC           : 1.360 V
5V              : 4.968 V
5VSB           : 5.112 V
VBAT           : 3.136 V
CPU Temperature : 60 degree C
SB INT Temperature : 36 degree C

CPU Fan Speed    : 2059 RPM_
▶ CPU Fan Configuration

CPU fan settings

><: Select Screen
↑↓: Select Item
Enter: Select
+/-: Change Opt.
F1: General Help
F2: Previous Values
F3: Optimized Defaults
F4: Save & Exit
ESC: Exit

Version 2.15.1236. Copyright (C) 2012 American Megatrends, Inc.

```

CPU Fan Configuration

```

Aptio Setup Utility - Copyright (C) 2012 American Megatrends, Inc.
  Advanced
CPU Fan Control [Enabled]
▶ CPU Fan Control

CPU Fan Control

><: Select Screen
↑↓: Select Item
Enter: Select
+/-: Change Opt.
F1: General Help
F2: Previous Values
F3: Optimized Defaults
F4: Save & Exit
ESC: Exit

Version 2.15.1223. Copyright (C) 2012 American Megatrends, Inc.

```

Feature	Options	Description
CPU Fan Control	Enabled Disabled	Enable or Disable onboard CPU Fan Control

CPU Fan Control

Aptio Setup Utility - Copyright (C) 2012 American Megatrends, Inc.

Advanced

<pre> CPU Fan Control CPU Fan Speed Mode [Step Mode] Fan Frequency [28.64KHZ] Hysteresis 10 PWM Step Rate 1 Temp. Treshold 0 70 Temp. Treshold 1 60 Temp. Treshold 2 50 Temp. Treshold 3 40 Critical Temp. 85 PWM Rate 0 100 PWM Rate 1 100 PWM Rate 2 0 PWM Rate 3 0 </pre>	<pre> CPU Fan Speed Mode ><: Select Screen ↑↓: Select Item Enter: Select +/-: Change Opt. F1: General Help F2: Previous Values F3: Optimized Defaults F4: Save & Exit ESC: Exit_ </pre>
--	--

Version 2.15.1223. Copyright (C) 2012 American Megatrends, Inc.

Feature	Options	Description
CPU Fan Speed Mode	Linear Mode Step Mode	Select CPU Fan Speed Mode
Fan Frequency	28.64kHz 25.78kHz 23.44kHz 21.48kHz 19.83kHz 18.41kHz 100Hz 87Hz 58Hz 44Hz 35Hz 29Hz 22Hz 14Hz 11Hz	Select CPU Fan Frequency
Hysteresis	1... 10 ...16	Select CPU Fan Hysteresis in K
PWM Step Rate	1...100	Select CPU Fan PWM Step Rate
Temp. Threshold 0	70	Temperature in °C at which PWM Rate 0 becomes active
Temp. Threshold 1	60	Temperature in °C at which PWM Rate 1 becomes active
Temp. Threshold 2	50	Temperature in °C at which PWM Rate 2 becomes active
Temp. Threshold 3	40	Temperature in °C at which PWM Rate 3 becomes active
Critical Temp.	85	Temperature in °C at which CPU fan will run at full speed
PWM Rate 0	100	CPU Fan PWM Rate 0 in %
PWM Rate 1	100	CPU Fan PWM Rate 1 in %
PWM Rate 2	0	CPU Fan PWM Rate 2 in %
PWM Rate 3	0	CPU Fan PWM Rate 3 in %

FDC37C669 Second Super IO Configuration

```
Aptio Setup Utility - Copyright (C) 2012 American Megatrends, Inc.
  Advanced
FDC37C669 Second Super IO Configuration
FDC37C669 Second Super IO Configuration
FDC37C669 Second Super IO Configuration
▶ Serial Port 0 Configuration
▶ Serial Port 1 Configuration
-
Set Parameters of
Serial Port 0 (COMA)

><: Select Screen
↑↓: Select Item
Enter: Select
+/-: Change Opt.
F1: General Help
F2: Previous Values
F3: Optimized Defaults
F4: Save & Exit
ESC: Exit

Version 2.15.1236. Copyright (C) 2012 American Megatrends, Inc.
```

Serial Port 0 Configuration

Aptio Setup Utility - Copyright (C) 2012 American Megatrends, Inc.
 Advanced

<p>Serial Port 0 Configuration</p> <p>Serial Port [Enabled] Device Settings IO=3E8h; IRQ=11;</p> <p>Change Settings [Auto]</p>	<p>Enable or Disable Serial Port (COM)</p> <hr/> <p>><: Select Screen ↑↓: Select Item Enter: Select +/-: Change Opt. F1: General Help F2: Previous Values F3: Optimized Defaults F4: Save & Exit ESC: Exit</p>
---	--

Version 2.15.1236. Copyright (C) 2012 American Megatrends, Inc.

Feature	Options	Description
Serial Port	Enabled Disabled	Enable or Disable Serial Port (COM)
Change Settings	Auto IO=3E8h; IRQ=11 IO=3F8h; IRQ=5,6,7,10,11 IO=2F8h; IRQ=5,6,7,10,11 IO=3E0h; IRQ=5,6,7,9,10,11 IO=2E8h; IRQ=5,6,7,9,10,11	Select an optimal setting for Super IO device

Serial Port 1 Configuration

Aptio Setup Utility - Copyright (C) 2012 American Megatrends, Inc.
Advanced

<p>Serial Port 1 Configuration</p> <p>Serial Port [Disabled]</p>	<p>Enable or Disable Serial Port (COM)</p> <hr/> <p>><: Select Screen ↑↓: Select Item Enter: Select +/-: Change Opt. F1: General Help F2: Previous Values F3: Optimized Defaults F4: Save & Exit ESC: Exit</p>
---	--

Version 2.15.1236. Copyright (C) 2012 American Megatrends, Inc.

Feature	Options	Description
Serial Port	Enabled Disabled	Enable or Disable Serial Port (COM)
Change Settings	Auto IO=2E8h; IRQ=10 IO=3F8h; IRQ=5,6,7,10,11 IO=2F8h; IRQ=5,6,7,10,11 IO=3E0h; IRQ=5,6,7,9,10,11 IO=2E8h; IRQ=5,6,7,9,10,11	Select an optimal setting for Super IO device
Device Mode	Standard Serial Port Mode IrDA 1.0 (HP SIR) Mode ASKIR Mode	Change the Serial Port mode

JMB36X ATA Controller Configuration

Aptio Setup Utility - Copyright (C) 2012 American Megatrends, Inc.

Advanced

<p>JMB 368 ATA Controlle [IDE Mode]</p> <p>PATA Primary Master Not Present PATA Primary Slave Not Present</p> <p>JMB 368 ATA Controlle [IDE Mode]</p> <p>PATA Secondary Master Not Present PATA Secondary Slave Not Present</p>	<p>Select an operative mode for ATA controller.</p> <hr/> <p>><: Select Screen ↑↓: Select Item Enter: Select +/-: Change Opt. F1: General Help F2: Previous Values F3: Optimized Defaults F4: Save & Exit ESC: Exit</p>
---	---

Version 2.15.1236. Copyright (C) 2012 American Megatrends, Inc.

Feature	Options	Description
JMB 368 ATA Controller	Disabled IDE Mode	Select an operative mode for ATA controller

Serial Port Console Redirection

Aptio Setup Utility - Copyright (C) 2012 American Megatrends, Inc.

Advanced

<pre> COM0 Console Redirection [Disabled] ▶ Console Redirection Settings COM1 Console Redirection [Disabled] ▶ Console Redirection Settings COM2(Pci Bus0,Dev0,Func0) (Disabled) Console Redirection Port Is Disabled Serial Port for Out-of-Band Management/ Windows Emergency Management Services (EMS) Console Redirection [Disabled] ▶ Console Redirection Settings </pre>	<pre> Console Redirection Enable or Disable. ----- ><: Select Screen ↑↓: Select Item Enter: Select +/-: Change Opt. F1: General Help F2: Previous Values F3: Optimized Defaults F4: Save & Exit ESC: Exit </pre>
---	--

Version 2.15.1223. Copyright (C) 2012 American Megatrends, Inc.

Feature	Options	Description
Console Redirection	Enabled Disabled	Enables or Disables Console Redirection for selected Port

COM0/COM1 Console Redirection Settings

Aptio Setup Utility - Copyright (C) 2012 American Megatrends, Inc.

Advanced

COM0 Console Redirection Settings		Emulation: ANSI: Extended ASCII char set. VT100: ASCII char set. VT100+: Extends VT100 to support color, function keys, etc. VT-UTF8: Uses UTF8 encoding to map Unicode chars onto 1 or more
Terminal Type Bits per second Data Bits Parity Stop Bits Flow Control VT-UTF8 Combo Key Sup Recorder Mode Resolution 100x31 Legacy OS Redirection Putty KeyPad Redirection After BIO	[ANSI] [115200] [8] [None] [1] [None] [Enabled] [Disabled] [Disabled] [80x24] [VT100] [Always Enable]	

><: Select Screen
 ↓: Select Item
 Enter: Select
 +/-: Change Opt.
 F1: General Help
 F2: Previous Values
 F3: Optimized Defaults
 F4: Save & Exit
 ESC: Exit

Version 2.15.1236. Copyright (C) 2012 American Megatrends, Inc.

Feature	Options	Description
Terminal Type	VT100 VT100+ VT_UTF8 ANSI	VT100: ASCII char set. VT100+: Extends VT100 to support color, function keys, etc. VT-UTF8: Uses UTF8 encoding to map Unicode chars onto 1 or more bytes ANSI: Extended ASCII char set.
Bits per second	9600 19200 38400 57600 115200	Selects serial port transmission speed. The speed must be matched on the other side. Long or noisy lines may require lower speeds
Data Bits	7 8	Data Bits
Parity	None Even Odd Mark Space	A parity bit can be sent with the data bits to detect some transmission errors. Even: parity bit is 0 if the num of 1's in the data bits is even. Odd: parity bit is 0 if num of 1's in the data bits is odd. Mark: parity bit is always 1. Space: Parity bit is always 0. Mark and Space Parity do not allow for error detection.
Stop Bits	1 2	Stop Bits indicate the end of a serial data packet. (A Start bit indicates the beginning). The standard setting is 1 stop bit. Communication with slow devices may require more than 1 stop bit.
Flow Control	None Hardware RTS/CTS	Flow control can prevent data loss from buffer overflow. When sending data, if the receiving buffers are full, a 'stop' signal can be sent to stop the data flow. Once the buffers are empty, a 'start' signal can be sent to re-start the flow. Hardware flow control uses two wires to send start/stop signals
VT-UTF8 Combo Key Support	Disabled Enabled	Enable VT-UTF8 Combination Key Support for ANSI/VT100 terminals
Recorder Mode	Disabled Enabled	With this mode enabled only text will be sent. This is to capture terminal data.
Resolution 100x31	Disabled Enabled	Enables or disables extended terminal resolution
Legacy OS Redirection Resolution	80x24 80x25	On Legacy OS, the Number of Rows and Columns supported redirection
Putty KeyPad	VT100 Linux XTERMR6 SCO ESCN VT400	Select Function Key and KeyPad on Putty
Redirection After BIOS	Always Enable Boot Loader	If Boot Loader is selected Legacy console redirection is disabled before booting to legacy OS

Serial Port for Out-of-Band Management Redirection Settings

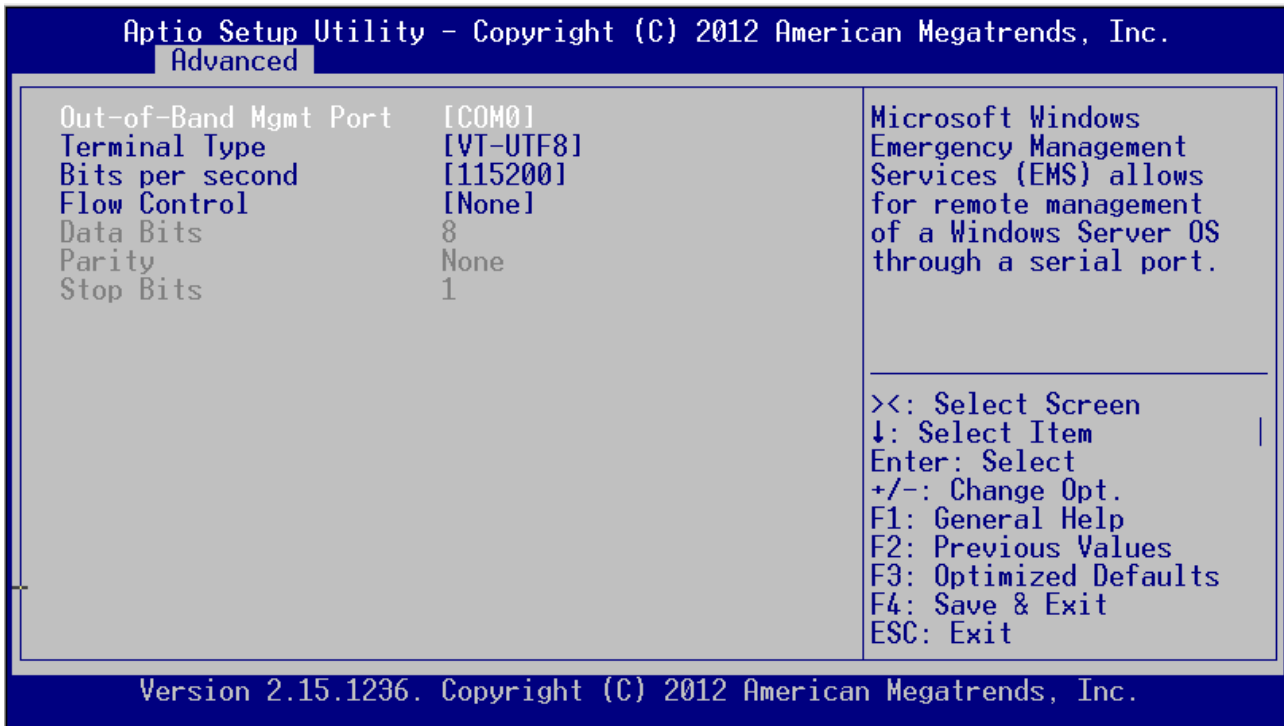

Feature	Options	Description
Out-of-Band Mgmt Port	COM0 COM1 COM2 (Disabled)	Microsoft Windows Emergency Management Services (EMS) allows for remote management of a Windows Server OS through a serial port
Terminal Type	VT100 VT100+ VT_UTF8 ANSI	VT100: ASCII char set. VT100+: Extends VT100 to support color, function keys, etc. VT-UTF8: Uses UTF8 encoding to map Unicode chars onto 1 or more bytes ANSI: Extended ASCII char set.
Bits per second	9600 19200 38400 57600 115200	Selects serial port transmission speed. The speed must be matched on the other side. Long or noisy lines may require lower speeds
Flow Control	None Hardware RTS/CTS	Flow control can prevent data loss from buffer overflow. When sending data, if the receiving buffers are full, a 'stop' signal can be sent to stop the data flow. Once the buffers are empty, a 'start' signal can be sent to re-start the flow. Hardware flow control uses two wires to send start/stop signals

Network Stack

Aptio Setup Utility - Copyright (C) 2012 American Megatrends, Inc.

Advanced

Network stack [Disabled]	Enable/Disable UEFI network stack
<pre> ><: Select Screen ↑↓: Select Item Enter: Select +/-: Change Opt. F1: General Help F2: Previous Values F3: Optimized Defaults F4: Save & Exit ESC: Exit </pre>	

Version 2.15.1236. Copyright (C) 2012 American Megatrends, Inc.

Feature	Options	Description
Network Stack	Disabled Enabled	Enable/Disable UEFI network stack
IPv4 PXE Support	Disabled Enabled	Enable IPv4 PXE Boot Support. If disabled IPv4 PXE boot option will not be created
IPv6 PXE Support	Disabled Enabled	Enable IPv6 PXE Boot Support. If disabled IPv6 PXE boot option will not be created

ITE8888 Configuration

```

Aptio Setup Utility - Copyright (C) 2012 American Megatrends, Inc.
  Advanced
ITE8888 Settings
ITE8888 ISA Decode      [Subtractive Decode]
Memory Hole 15MB-16MB  [Disabled]
Memory Hole D-Segment  [Disabled]
▶ Distributed DMA Channels

Section for ISA
Positively Decode or
Subtractive Decode

><: Select Screen
↑↓: Select Item
Enter: Select
+/-: Change Opt.
F1: General Help
F2: Previous Values
F3: Optimized Defaults
F4: Save & Exit
ESC: Exit

Version 2.15.1236. Copyright (C) 2012 American Megatrends, Inc.
    
```

Feature	Options	Description
ITE8888 ISA Decode	Subtractive Decode Positively Decode	Section for ISA Positively Decode or Subtractive Decode
Memory Hole 15MB-16MB	Disabled Enabled	Memory Hole 15MB-16MB
Memory Hole D-Segment	Disabled Enabled	Enable/Disable Memory Hole @ shadow address D0000:0

Distributed DMA Channel

Aptio Setup Utility - Copyright (C) 2012 American Megatrends, Inc.
Advanced

DDMA Slave Channel 0	[Disabled]	Enable/Disable DDMA Slave Channel 0
DDMA Slave Channel 1	[Disabled]	
DDMA Slave Channel 2	[Disabled]	
DDMA Slave Channel 3	[Disabled]	
DDMA Slave Channel 5	[Disabled]	
DDMA Slave Channel 6	[Disabled]	
DDMA Slave Channel 7	[Disabled]	

Version 2.15.1236. Copyright (C) 2012 American Megatrends, Inc.

Feature	Options	Description
DDMA Slave Channel 0 - 7	Disabled Enabled	Enable/Disable DDMA Slave Channels

	Medium Speed Fast Speed	
I/O Decoding Base Address	340	Select I/O space Decoding Base Address A[15:0]
I/O Decoding Size	32 Byte	Select I/O space Decoding Size from 1 Byte to 128 Byte

ISA Decode Memory Space

Aptio Setup Utility – Copyright (C) 2012 American Megatrends, Inc.

Advanced

Memory Space 0	[Enabled]	Positively Decode Memory Space Window 0
Memory Decoding Speed	[Medium Speed]	
Memory Decoding Base	d00	
Memory Decoding Size	[64 KB]	
Memory Space 1	[Disabled]	
Memory Space 2	[Disabled]	
Memory Space 3	[Disabled]	

><: Select Screen
 ↑↓: Select Item
 Enter: Select
 +/-: Change Opt.
 F1: General Help
 F2: Previous Values
 F3: Optimized Defaults
 F4: Save & Exit
 ESC: Exit_

Version 2.15.1236. Copyright (C) 2012 American Megatrends, Inc.

Feature	Options	Description
Memory Space 0	Disabled Enabled	Positively Decode Memory Space Window
Memory Decoding Speed	Subtractive Speed Slow Speed Medium Speed Fast Speed	Select Memory Space Decoding Speed
Memory Decoding Base Address	d00	Select Memory space Decoding Base Address A[23:8]
Memory Decoding Size	64 KB	Select I/O space Decoding Size from 16 kByte to 2MB
Memory Space 1/2/3	Disabled Enabled	Positively Decode Memory Space Window
Memory Decoding Speed	Subtractive Speed Slow Speed Medium Speed Fast Speed	Select Memory Space Decoding Speed
Memory Decoding Base Address	0	Select Memory space Decoding Base Address A[23:8]
Memory Decoding Size	32 Byte	Select I/O space Decoding Size from 16 kByte to 2MB

7.5.3 Chipset

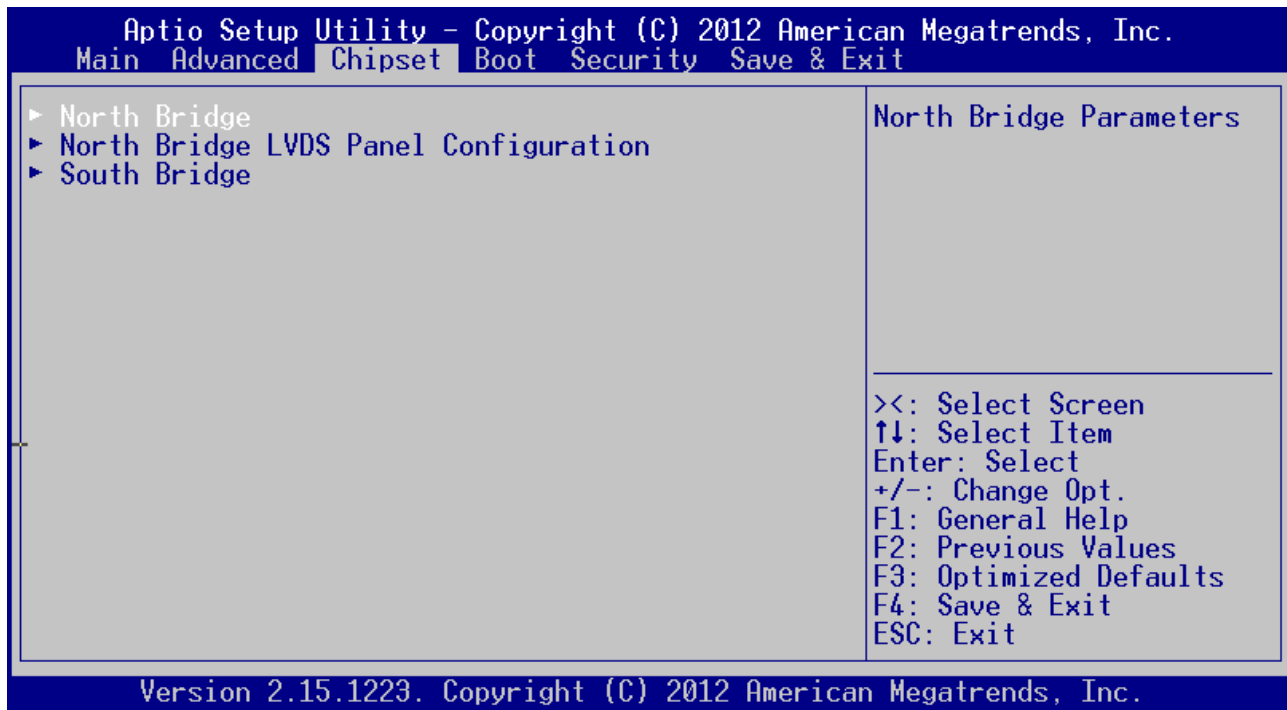

North Bridge

Aptio Setup Utility - Copyright (C) 2012 American Megatrends, Inc.
Chipset

<p>North Bridge Configuration</p> <p>Memory Clock [Auto] Memory Clear [Not Cleared]</p> <p>Memory Information Memory Clock: 667 MHZ Total Memory: 4080 MB (DDR3)</p> <p>▶ Memory Configuration ▶ Socket 0 Information</p>	<p>This Option Allows User to select different Memory Clock. Default value is 400Mhz.</p> <hr/> <p>><: Select Screen ↑↓: Select Item Enter: Select +/-: Change Opt. F1: General Help F2: Previous Values F3: Optimized Defaults F4: Save & Exit ESC: Exit</p>
---	---

Version 2.15.1236. Copyright (C) 2012 American Megatrends, Inc.

Feature	Options	Description
Memory Clock	Auto 400MHz 533MHz 667MHz	Manual Memory clock selection from DDR3-800 to DDR3-1333
Memory Clear	Not Cleared Cleared	Memory Clear functionality control

Memory Configuration

Aptio Setup Utility – Copyright (C) 2012 American Megatrends, Inc.
Chipset

<p>Memory Configuration</p> <p>Integrated Graphics [Auto] Bank Interleaving [Enabled] IOMMU Mode [Disabled] Memory Clock [Auto] Memory Clear [Not Cleared]</p>	<p>Enable Integrated Graphics controller</p> <hr/> <p>><: Select Screen ↑↓: Select Item Enter: Select +/-: Change Opt. F1: General Help F2: Previous Values F3: Optimized Defaults F4: Save & Exit ESC: Exit</p>
--	--

Version 2.15.1223. Copyright (C) 2012 American Megatrends, Inc.

Feature	Options	Description
Integrated Graphics	Auto Disabled Force	Enable Integrated Graphics controller
Bank Interleaving	Disabled Enabled	Bank Interleaving
UMA Frame buffer Size	32MB 64MB 128MB 256MB 512MB 1GB 2GB	Set UMA FB size

Socket 0 Information

Aptio Setup Utility - Copyright (C) 2012 American Megatrends, Inc.
Chipset

<p>Socket 0 Information</p> <p>Starting Address: 0KB Ending Address: 4980736KB</p> <p>Dimm0: size = 4096MB, speed = 800MHz Dimm1: Not Present</p>	<p>><: Select Screen ↑↓: Select Item Enter: Select +/-: Change Opt. F1: General Help F2: Previous Values F3: Optimized Defaults F4: Save & Exit ESC: Exit</p>
---	---

Version 2.15.1236. Copyright (C) 2012 American Megatrends, Inc.

North Bridge LVDS Panel Configuration

Aptio Setup Utility – Copyright (C) 2012 American Megatrends, Inc.
Chipset

Specify options for DisplayPorts and LVDS	NB PCIE Connect Type (Display device)
DP0 Output Mode [DP-to-LVDS]	
DP1 Output Mode [Disabled]	
Flat Panel Type [AUTO]	
Panel Color Depth [18 Bit]	
LVDS Protocol [FPDI Mode]	
LVDS Spread Spectrum [Disabled]	
Backlight Control [None/External]	
	><: Select Screen ↑↓: Select Item Enter: Select +/-: Change Opt. F1: General Help F2: Previous Values F3: Optimized Defaults F4: Save & Exit ESC: Exit

Version 2.15.1236. Copyright (C) 2012 American Megatrends, Inc.

Feature	Options	Description
DP0 Output Mode	DP-to-LVDS Disabled	Enable/Disable onboard Displayport to LVDS conversion from APU DPO
DP1 Output Mode	DP DP-to-LVDS Single Link DVI-I Single Link DVI-D HDMI Disabled	Select DisplayPort mode for onboard DP connector
Flat Panel Type	Auto 640×480 800×480 800×600 1024×768 1280×720 1280×800 1280×1024 1366×768 1440×900 1600×900 18bit 1920×1080	Use VESA EDID to auto-configure LVDS Panel or select predefined Timing
Panel Color Depth	18 Bit 24 Bit	For internal LVDS EDID 1.3 detection, select the Panel Color Depth
LVDS Protocol	LDI Mode FPDI Mode	LVDS 24 bit protocol mode
LVDS Spread Spectrum	Disabled Enabled	LVDS Spread Spectrum control
Backlight Control	None/External PWM PWM Inverted	Backlight Control setting

South Bridge

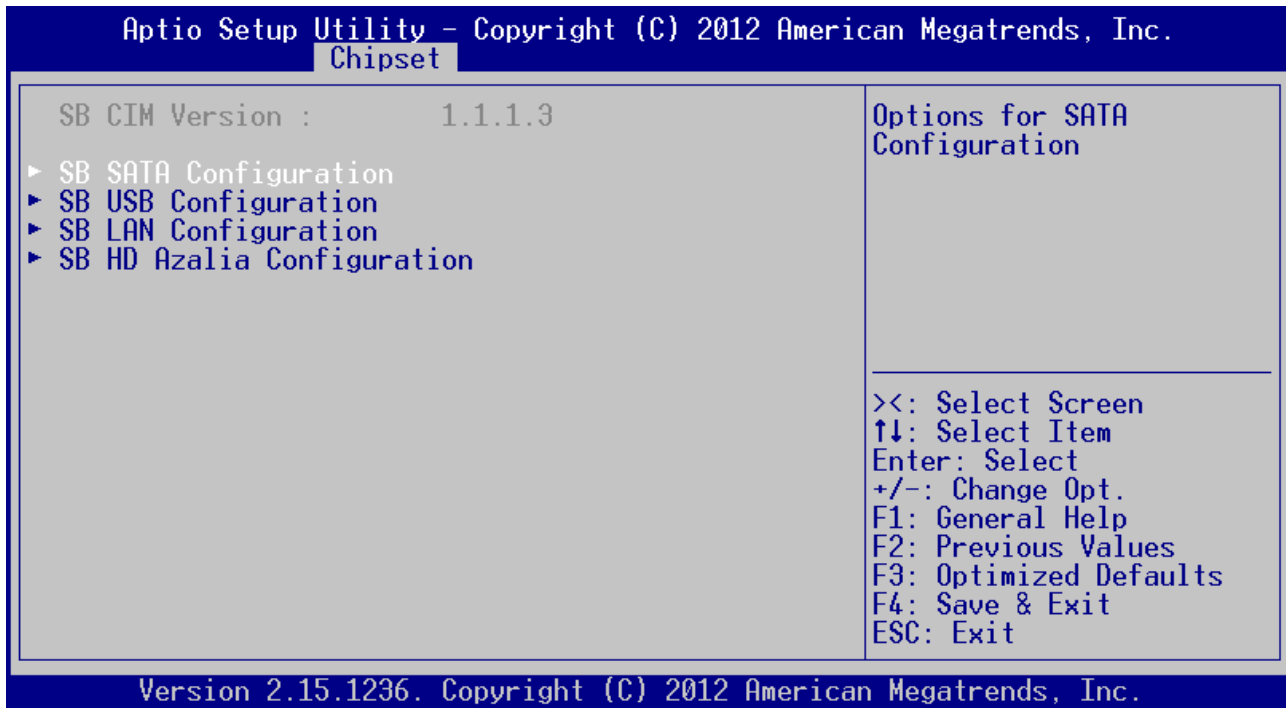

SB SATA Configuration

Aptio Setup Utility – Copyright (C) 2012 American Megatrends, Inc.

Chipset

SATA Controller	[Enabled]	Enable Or Disable Serial ATA
OnChip SATA Type	[AHCI]	
SATA IDE Combined Mod	[Disabled]	
PORT0 External	[Disabled]	><: Select Screen ↑↓: Select Item Enter: Select +/-: Change Opt. F1: General Help F2: Previous Values F3: Optimized Defaults F4: Save & Exit ESC: Exit
PORT1 External	[Disabled]	
SATA Power on PORT0	[Enabled]	
SATA Power on PORT1	[Enabled]	
SATA PORT0 MODE	[GEN1]	
SATA PORT1 MODE	[GEN1]	
SATA PORT4 MODE	[GEN1]	

Version 2.15.1236. Copyright (C) 2012 American Megatrends, Inc.

Feature	Options	Description
OnChip SATA Channel	Disabled Enabled	Enable/Disable Serial ATA
OnChip SATA Type	Native IDE RAID AHCI Legacy IDE IDE→AHCI AHCI as ID 0x4394 IDE→AHCI as ID 0x4394	Native IDE, RAID, AHCI, AHCI Legacy, IDE, IDE→AHCI HyperFlash
SATA Force Raid	No Function Force Raid	No Function: Raid 5, Force Raid: Raid0/1
OnChip IDE mode	Legacy mode Native mode	OnChip IDE mode Select
SATA IDE Combined Mode	Enabled Disabled	Enable or Disable SATA IDE Combined Mode
Combined Mode Option	SATA as primary SATA as secondary	Combined Mode Option
PORT0 External	Disabled Enabled	Enable or Disable SATA External Port Mode on PORT0
PORT1 External	Disabled Enabled	Enable or Disable SATA External Port Mode on PORT1
SATA Power on Port0	Enabled Power Down	Enable or Disable SATA SATA Power on PORT0
SATA Power on Port1	Enabled Power Down	Enable or Disable SATA SATA Power on PORT1
SATA PORT0 Mode	Auto GEN1 GEN2	Select SATA Generation Mode for onboard SATA Port0
SATA PORT1 Mode	Auto GEN1 GEN2	Select SATA Generation Mode for onboard SATA Port1
SATA PORT4 Mode	Auto GEN1 GEN2	Select SATA Generation Mode for onboard SATA SSD on Port4

SB USB Configuration

Aptio Setup Utility – Copyright (C) 2012 American Megatrends, Inc.
Chipset

OHCI/EHCI Host Contro	[Enabled]	Enable Or Disable OHCI and EHCI Host Controller 1 controlling external USB Ports 0 to 3 (Bus 0 Dev 18 Fn 0 and 2)
OHCI/EHCI Host Contro	[Enabled]	
USB PORT 0	[Enabled]	
USB PORT 1	[Enabled]	
USB PORT 2	[Enabled]	
USB PORT 3	[Enabled]	
USB PORT 5	[Enabled]	
USB PORT 6	[Enabled]	
USB Device Wakeup Fro	[Enabled]	

><: Select Screen
 ↑↓: Select Item
 Enter: Select
 +/-: Change Opt.
 F1: General Help
 F2: Previous Values
 F3: Optimized Defaults
 F4: Save & Exit
 ESC: Exit

Version 2.15.1236. Copyright (C) 2012 American Megatrends, Inc.

Feature	Options	Description
OHCI/EHCI Host Controller 1	Disabled Enabled	Enable or Disable OHCI and EHCI Host Controller 1 controlling external USB Ports 0 to 3 (Bus 0 Dev 18 Fn 0 and 2)
OHCI/EHCI Host Controller 2	Disabled Enabled	Enable or Disable OHCI and EHCI Host Controller 1 controlling onboard USB Ports 5 and 6 (Bus 0 Dev 19 Fn 0 and 2)
USB PORT 0	Disabled Enabled	Enable/Disable USB PORT 0
USB PORT 1	Disabled Enabled	Enable/Disable USB PORT 1
USB PORT 2	Disabled Enabled	Enable/Disable USB PORT 2
USB PORT 3	Disabled Enabled	Enable/Disable USB PORT 3
USB PORT 5	Disabled Enabled	Enable/Disable USB PORT 5
USB PORT 6	Disabled Enabled	Enable/Disable USB PORT 6
USB Device Wakeup From S3 or S4	Disabled Enabled	Enable/Disable USB Device Wakeup From S3 or S4

SB LAN Configuration

Aptio Setup Utility – Copyright (C) 2012 American Megatrends, Inc.

Chipset

In-Chip NIC WOL Resume Wake from LAN OPROM	[Enabled] [Disabled] [Disabled]	Enable Or Disable In-Chip NIC
-		
		><: Select Screen ↑↓: Select Item Enter: Select +/-: Change Opt. F1: General Help F2: Previous Values F3: Optimized Defaults F4: Save & Exit ESC: Exit

Version 2.15.1236. Copyright (C) 2012 American Megatrends, Inc.

Feature	Options	Description
In-Chip NIC	Enabled Disabled	Enable/Disable Internal Gigabit Ethernet Controller
WOL Resume from S5	Disabled Enabled	Enable or Disable Wake on LAN (WOL) Resume from S5 Note: Wake on LAN from S5 is not supported
LAN OPROM	Disabled Enabled	Enable/Disable LAN OPROM

SB HD Azalia Configuration

Aptio Setup Utility – Copyright (C) 2012 American Megatrends, Inc.

Chipset

HD Audio Azalia Devic [Enabled]	Enable Or Disable HD Audio Azalia Device <hr/> ><: Select Screen ↑↓: Select Item Enter: Select +/-: Change Opt. F1: General Help F2: Previous Values F3: Optimized Defaults F4: Save & Exit ESC: Exit
---------------------------------	--

Version 2.15.1236. Copyright (C) 2012 American Megatrends, Inc.

Feature	Options	Description
HD Audio Azalia Device	Auto Disabled Enabled	Enable/Disable HD Audio Azalia Device

7.5.4 Boot

```

Aptio Setup Utility - Copyright (C) 2012 American Megatrends, Inc.
Main Advanced Chipset Boot Security Save & Exit

Boot Configuration
Setup Prompt Timeout      0
Bootup NumLock State     [On]

Quiet Boot                [Enabled]
Fast Boot                 [Disabled]
New HDD Priority          [Low]

Bootmenu Type             [Device Based]

Boot Option Priorities
Boot Option #1            [SATA 0: SanDisk SSD...]
Boot Option #2            [UEFI: Built-in EFI ...]
▶ CSM16 Parameters
  CSM parameters

▶ Add New Boot Option
▶ Delete Boot Option

>>: Select Screen
↓: Select Item
Enter: Select
+/-: Change Opt.
F1: General Help
F2: Previous Values
F3: Optimized Defaults
F4: Save & Exit
ESC: Exit

Version 2.15.1236. Copyright (C) 2012 American Megatrends, Inc.

```

Feature	Options	Description
Setup Prompt Timeout	1	Number of seconds to wait for setup activation key. 65535 (0xFFFF) means indefinite waiting
Bootup NumLock State	On Off	Select the keyboard NumLock state
Quiet Boot	Disabled Enabled	Enable/Disable Quiet boot option
Fast Boot	Disabled Enabled	Enable/Disable boot with initialization of a minimal set of devices required to launch active boot option. Has no effect for BBS boot options. If enabled, System enters BIOS setup when standard boot-up process fails
Bootmenu Type	Device Based Port Based	Enables Device or Port based Bootmenu
Boot Port 1 ... 4	Disabled UEFI Shell PATA 0 ... 3 SATA 0 ... 3 USB OPROM 1 OPROM2 Any Device	USB devices behind hubs are not supported by Port Based Bootmenu. Use Device Based Bootmenu for those devices
Boot Option #	Device Disabled	Select or Disable Boot Option to set the system boot order

CSM16 Parameters

Aptio Setup Utility - Copyright (C) 2012 American Megatrends, Inc.

Boot

CSM16 Parameters CSM16 Module Version 07.70 GateA20 Active [Upon Request] Option ROM Messages [Force BIOS] INT19 Trap Response [Postponed]		UPON REQUEST - GA20 can be disabled using BIOS services. ALWAYS - do not allow disabling GA20; this option is useful when any RT code is executed above 1MB.
		><: Select Screen ↑↓: Select Item Enter: Select +/-: Change Opt. F1: General Help F2: Previous Values F3: Optimized Defaults F4: Save & Exit ESC: Exit

Version 2.15.1236. Copyright (C) 2012 American Megatrends, Inc.

GateA20 Active	Upon Request Always	UPON REQUEST - GA20 can be disabled using BIOS services. ALWAYS - do not allow disabling GA20; this option is useful when any RT code is executed above 1MB
Option ROM Messages	Force BIOS Keep Current	Set display mode for Option ROM
INT19 Trap Response	Immediate Postponed	BIOS reaction on INT19 trapping by Option ROM: IMMEDIATE - execute the trap right away; POSTPONED - execute the trap during legacy boot

CSM Parameters

Aptio Setup Utility - Copyright (C) 2012 American Megatrends, Inc.

Boot

Launch CSM	[Enabled]	This option controls if CSM will be launched
Boot option filter	[UEFI and Legacy]	
Launch PXE OpROM poli	[UEFI only]	
Launch Storage OpROM	[UEFI first]	
Launch Video OpROM po	[Legacy first]	
Other PCI device ROM	[UEFI OpROM]	

><: Select Screen
 ↑↓: Select Item
 Enter: Select
 +/-: Change Opt.
 F1: General Help
 F2: Previous Values
 F3: Optimized Defaults
 F4: Save & Exit
 ESC: Exit

Version 2.15.1236. Copyright (C) 2012 American Megatrends, Inc.

Feature	Options	Description
Launch CSM	Enabled Disabled	This option controls if CSM will be launched
Boot option filter	UEFI and Legacy Legacy only UEFI only	This option controls what devices system can boot to
Launch PXE OpROM	Do not launch UEFI only Legacy only Legacy first UEFI first	Controls the execution of UEFI and Legacy PXE OpROM
Launch Storage OpROM	Do not launch UEFI only Legacy only Legacy first UEFI first	Controls the execution of UEFI and Legacy Storage OpROM
Launch Video OpROM	Do not launch UEFI only Legacy only Legacy first UEFI first	Controls the execution of UEFI and Legacy Video OpROM
Other PCI device ROM	UEFI OpROM Legacy OpROM	For PCI devices other than Network, Mass Storage or Video defines which OpROM to launch

Add New Boot Option

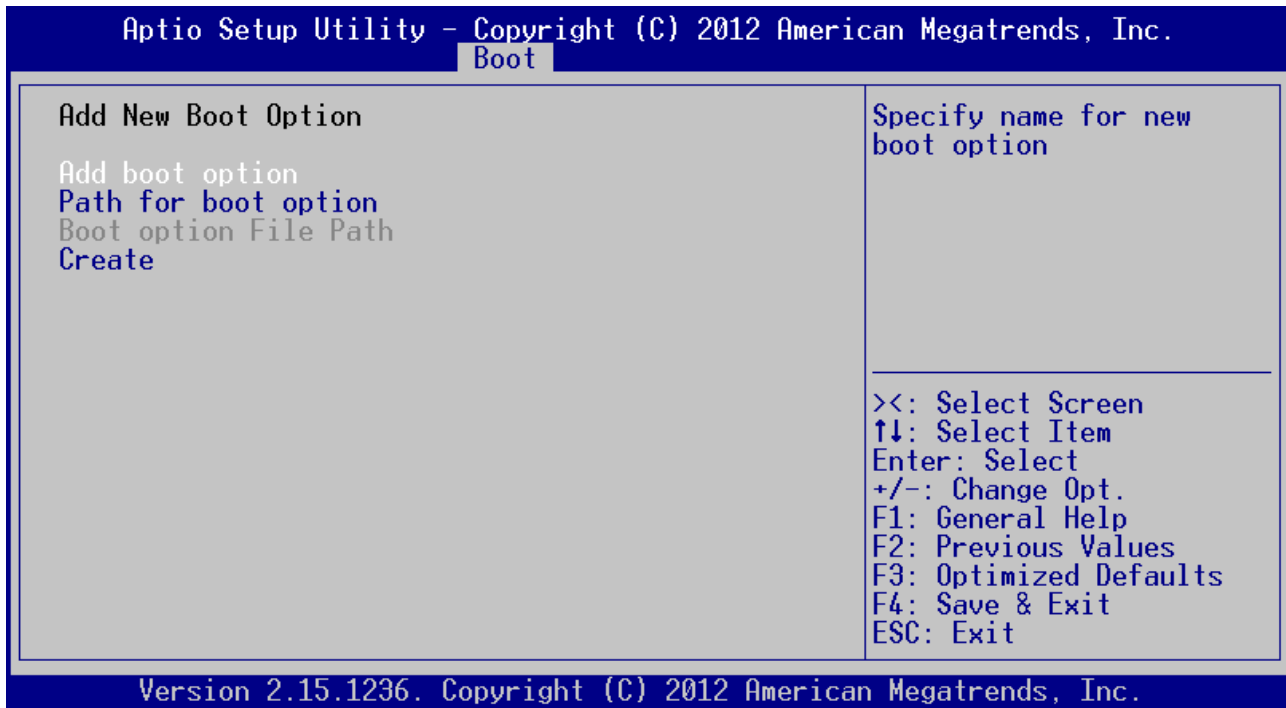

Feature	Options	Description
Add boot option	-	Specify name of new boot option
Path for boot option	-	Enter the path to the boot option in the format fsx:\path\filename.efi
Path for boot option	-	Creates the newly formed boot option

Delete Boot Option

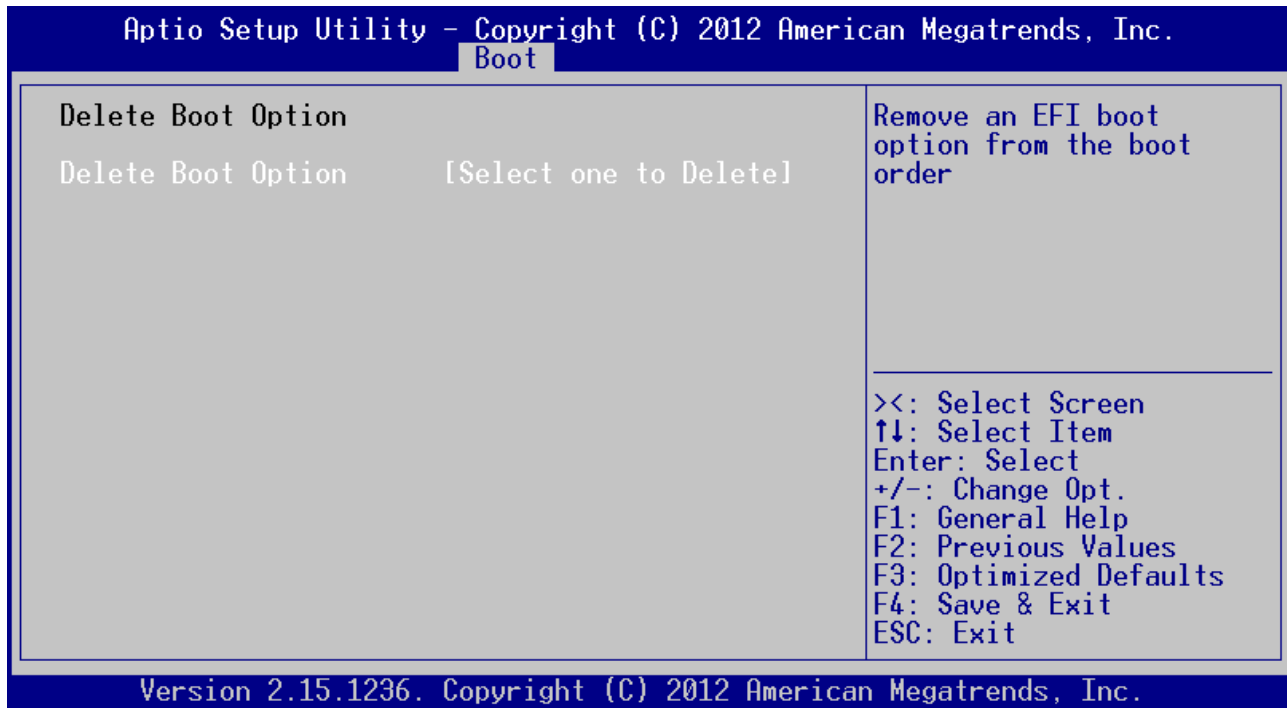

Feature	Options	Description
Delete Boot Option	List of current boot options	Remove an EFI boot option from the boot order

7.5.5 Security

Aptio Setup Utility - Copyright (C) 2012 American Megatrends, Inc.
 Main Advanced Chipset Boot Security Save & Exit

<p>Password Description</p> <p>If ONLY the Administrator's password is set, then this only limits access to Setup and is only asked for when entering Setup. If ONLY the User's password is set, then this is a power on password and must be entered to boot or enter Setup. In Setup the User will have Administrator rights. The password length must be in the following range:</p> <p>Minimum length 3 Maximum length 20</p> <p>Administrator Password User Password</p>	<p>Set Administrator Password</p> <hr/> <p>><: Select Screen ↑↓: Select Item Enter: Select +/-: Change Opt. F1: General Help F2: Previous Values F3: Optimized Defaults F4: Save & Exit ESC: Exit</p>
---	---

Version 2.15.1223. Copyright (C) 2012 American Megatrends, Inc.

Feature	Options	Description
Set Administrator Password	-	Set the Administrator Password for Setup Access
User Password	-	Set User Password

7.5.6 Save & Exit

```

Aptio Setup Utility - Copyright (C) 2012 American Megatrends, Inc.
Main Advanced Chipset Boot Security Save & Exit
Save Changes and Exit
Discard Changes and Exit
Save Changes and Reset
Discard Changes and Reset

Save Options
Save Changes
Discard Changes

Restore Defaults
Save as User Defaults
Restore User Defaults

Boot Override
UEFI: Built-in EFI Shell

Exit system setup after
saving the changes.

><: Select Screen
↑↓: Select Item
Enter: Select
+/-: Change Opt.
F1: General Help
F2: Previous Values
F3: Optimized Defaults
F4: Save & Exit
ESC: Exit

Version 2.15.1223. Copyright (C) 2012 American Megatrends, Inc.

```

Feature	Options	Description
Save Changes and Exit	-	Exit system setup after saving the changes
Discard Changes and Exit	-	Exit system setup without saving any changes
Save Changes and Reset	-	Reset system after saving the changes
Discard Changes and Reset	-	Reset system without saving any changes
Save Changes	-	Save changes made so far to any of the setup options
Discard Changes	-	Discard changes made so far to any of the setup options
Restore Defaults	-	Restore/Load Default values for all the setup options
Save as User Defaults	-	Save the changes made so far as User Defaults
Restore User Defaults	-	Restore the User Defaults to all the setup options
Boot Override	List of all boot options	Boot directly from selected device

Corporate Offices

<p>Europe, Middle East & Africa Oskar-von-Miller-Str. 1 85386 Eching/Munich Germany Tel.: +49 (0)8165/ 77 777 Fax: +49 (0)8165/ 77 219 info@kontron.com</p>	<p>North America 14118 Stowe Drive Poway, CA 92064-7147 USA Tel.: +1 888 294 4558 Fax: +1 858 677 0898 info@us.kontron.com</p>	<p>Asia Pacific 17 Building,Block #1,ABP. 188 Southern West 4th Ring Beijing 100070, P.R.China Tel.: + 86 10 63751188 Fax: + 86 10 83682438 info@kontron.cn</p>	
--	--	---	---