

## 3.5"-SBC-APL

Doc. User Guide Rev. 1.3

Doc. ID: 1061-0789

This page has been intentionally left blank

 3.5"-SBC-APL – USER GUIDE

## Disclaimer

Kontron would like to point out that the information contained in this user guide may be subject to alteration, particularly as a result of the constant upgrading of Kontron products. This document does not entail any guarantee on the part of Kontron with respect to technical processes described in the user guide or any product characteristics set out in the user guide. Kontron assumes no responsibility or liability for the use of the described product(s), conveys no license or title under any patent, copyright or mask work rights to these products and makes no representations or warranties that these products are free from patent, copyright or mask work right infringement unless otherwise specified. Applications that are described in this user guide are for illustration purposes only. Kontron makes no representation or warranty that such application will be suitable for the specified use without further testing or modification. Kontron expressly informs the user that this user guide only contains a general description of processes and instructions which may not be applicable in every individual case. In cases of doubt, please contact Kontron.

This user guide is protected by copyright. All rights are reserved by Kontron. No part of this document may be reproduced, transmitted, transcribed, stored in a retrieval system, or translated into any language or computer language, in any form or by any means (electronic, mechanical, photocopying, recording, or otherwise), without the express written permission of Kontron. Kontron points out that the information contained in this user guide is constantly being updated in line with the technical alterations and improvements made by Kontron to the products and thus this user guide only reflects the technical status of the products by Kontron at the time of publishing.

Brand and product names are trademarks or registered trademarks of their respective owners.

© 2020 by Kontron S&T AG

Kontron S&T AG

Lise-Meitner-Str. 3-5

86156 Augsburg

Germany

[www.kontron.com](http://www.kontron.com)

## High Risk Applications Hazard Notice

THIS DEVICE AND ASSOCIATED SOFTWARE ARE NOT DESIGNED, MANUFACTURED OR INTENDED FOR USE OR RESALE FOR THE OPERATION OF NUCLEAR FACILITIES, THE NAVIGATION, CONTROL OR COMMUNICATION SYSTEMS FOR AIRCRAFT OR OTHER TRANSPORTATION, AIR TRAFFIC CONTROL, LIFE SUPPORT OR LIFE SUSTAINING APPLICATIONS, WEAPONS SYSTEMS, OR ANY OTHER APPLICATION IN A HAZARDOUS ENVIRONMENT, OR REQUIRING FAIL-SAFE PERFORMANCE, OR IN WHICH THE FAILURE OF PRODUCTS COULD LEAD DIRECTLY TO DEATH, PERSONAL INJURY, OR SEVERE PHYSICAL OR ENVIRONMENTAL DAMAGE (COLLECTIVELY, "HIGH RISK APPLICATIONS").

You understand and agree that your use of Kontron devices as a component in High Risk Applications is entirely at your risk. To minimize the risks associated with your products and applications, you should provide adequate design and operating safeguards. You are solely responsible for compliance with all legal, regulatory, safety, and security related requirements concerning your products. You are responsible to ensure that your systems (and any Kontron hardware or software components incorporated in your systems) meet all applicable requirements. Unless otherwise stated in the product documentation, the Kontron device is not provided with error-tolerance capabilities and cannot therefore be deemed as being engineered, manufactured or setup to be compliant for implementation or for resale as device in High Risk Applications. All application and safety related information in this document (including application descriptions, suggested safety measures, suggested Kontron products, and other materials) is provided for reference only.

---

**⚠ CAUTION**

Handling and operation of the product is permitted only for trained personnel within a work place that is access controlled. Please follow the "General Safety Instructions for IT Equipment" supplied with the system.

---

## Revision History

Revision	Brief Description of Changes	Date of Issue	Author
1.0	Basic issue	2018-Mar-07	hjs
1.1	Corrected COM1, COM2 and USB1	2018-Oct-26	CW
1.2	Layout modifications	2019-Jul-25	hjs
1.3	Feature Connector in chapter 17 added	2020-Jul-14	hjs

## Terms and Conditions

Kontron warrants products in accordance with defined regional warranty periods. For more information about warranty compliance and conformity, and the warranty period in your region, visit <http://www.kontron.com/terms-and-conditions>.

Kontron sells products worldwide and declares regional General Terms & Conditions of Sale, and Purchase Order Terms & Conditions. Visit <http://www.kontron.com/terms-and-conditions>.

For contact information, refer to the corporate offices contact information on the last page of this user guide or visit our website [CONTACT US](#).

## Customer Support

Find Kontron contacts by visiting: <http://www.kontron.com/support>.

## Customer Service

As a trusted technology innovator and global solutions provider, Kontron extends its embedded market strengths into a services portfolio allowing companies to break the barriers of traditional product lifecycles. Proven product expertise coupled with collaborative and highly-experienced support enables Kontron to provide exceptional peace of mind to build and maintain successful products.

For more details on Kontron's service offerings such as: enhanced repair services, extended warranty, Kontron training academy, and more visit <http://www.kontron.com/support-and-services/services>.

## Customer Comments

If you have any difficulties using this user guide, discover an error, or just want to provide some feedback, contact [Kontron support](#). Detail any errors you find. We will correct the errors or problems as soon as possible and post the revised user guide on our website.

## Symbols

The following symbols may be used in this user guide

### **⚠ DANGER**

DANGER indicates a hazardous situation which, if not avoided, will result in death or serious injury.

### **⚠ WARNING**

WARNING indicates a hazardous situation which, if not avoided, could result in death or serious injury.

### **⚠ CAUTION**

CAUTION indicates a hazardous situation which, if not avoided, may result in minor or moderate injury.

### **NOTICE**

NOTICE indicates a property damage message.



Electric Shock!

This symbol and title warn of hazards due to electrical shocks (> 60 V) when touching products or parts of products. Failure to observe the precautions indicated and/or prescribed by the law may endanger your life/health and/or result in damage to your material.



ESD Sensitive Device!

This symbol and title inform that the electronic boards and their components are sensitive to static electricity. Care must therefore be taken during all handling operations and inspections of this product in order to ensure product integrity at all times.



HOT Surface!

Do NOT touch! Allow to cool before servicing.



Laser!

This symbol inform of the risk of exposure to laser beam from an electrical device. Eye protection per manufacturer notice shall review before servicing.



This symbol indicates general information about the product and the user guide.

This symbol also indicates detail information about the specific product configuration.



This symbol precedes helpful hints and tips for daily use.

## For Your Safety

Your new Kontron product was developed and tested carefully to provide all features necessary to ensure its compliance with electrical safety requirements. It was also designed for a long fault-free life. However, the life expectancy of your product can be drastically reduced by improper treatment during unpacking and installation. Therefore, in the interest of your own safety and of the correct operation of your new Kontron product, you are requested to conform with the following guidelines.

### High Voltage Safety Instructions

As a precaution and in case of danger, the power connector must be easily accessible. The power connector is the product's main disconnect device.

#### ⚠ CAUTION

##### Warning

All operations on this product must be carried out by sufficiently skilled personnel only.

#### ⚠ CAUTION



##### Electric Shock!

Before installing a non hot-swappable Kontron product into a system always ensure that your mains power is switched off. This also applies to the installation of piggybacks. Serious electrical shock hazards can exist during all installation, repair, and maintenance operations on this product. Therefore, always unplug the power cable and any other cables which provide external voltages before performing any work on this product.

Earth ground connection to vehicle's chassis or a central grounding point shall remain connected. The earth ground cable shall be the last cable to be disconnected or the first cable to be connected when performing installation or removal procedures on this product.

### Special Handling and Unpacking Instruction

#### NOTICE



##### ESD Sensitive Device!

Electronic boards and their components are sensitive to static electricity. Therefore, care must be taken during all handling operations and inspections of this product, in order to ensure product integrity at all times.

Do not handle this product out of its protective enclosure while it is not used for operational purposes unless it is otherwise protected.

Whenever possible, unpack or pack this product only at EOS/ESD safe work stations. Where a safe work station is not guaranteed, it is important for the user to be electrically discharged before touching the product with his/her hands or tools. This is most easily done by touching a metal part of your system housing.

It is particularly important to observe standard anti-static precautions when changing piggybacks, ROM devices, jumper settings etc. If the product contains batteries for RTC or memory backup, ensure that the product is not placed on conductive surfaces, including anti-static plastics or sponges. They can cause short circuits and damage the batteries or conductive circuits on the product.

## General Instructions on Usage

In order to maintain Kontron's product warranty, this product must not be altered or modified in any way. Changes or modifications to the product, that are not explicitly approved by Kontron and described in this user guide or received from Kontron's Technical Support as a special handling instruction, will void your warranty.

This product should only be installed in or connected to systems that fulfill all necessary technical and specific environmental requirements. This also applies to the operational temperature range of the specific board version, that must not be exceeded. If batteries are present, their temperature restrictions must be taken into account.

In performing all necessary installation and application operations, only follow the instructions supplied by the present User Guide.

Keep all the original packaging material for future storage or warranty shipments. If it is necessary to store or ship the product then re-pack it in the same manner as it was delivered.

Special care is necessary when handling or unpacking the product. See Special Handling and Unpacking Instruction.

## Environmental Protection Statement

This product has been manufactured to satisfy environmental protection requirements where possible. Many of the components used (structural parts, printed circuit boards, connectors, batteries, etc.) are capable of being recycled.

Final disposition of this product after its service life must be accomplished in accordance with applicable country, state, or local laws or regulations.



Environmental protection is a high priority with Kontron.  
Kontron follows the WEEE directive  
You are encouraged to return our products for proper disposal.

The Waste Electrical and Electronic Equipment (WEEE) Directive aims to:

- ▶ Reduce waste arising from electrical and electronic equipment (EEE)
- ▶ Make producers of EEE responsible for the environmental impact of their products, especially when the product become waste
- ▶ Encourage separate collection and subsequent treatment, reuse, recovery, recycling and sound environmental disposal of EEE
- ▶ Improve the environmental performance of all those involved during the lifecycle of EEE
- ▶

Special care is necessary when handling or unpacking the product. See Special Handling and Unpacking Instruction.

## Lithium Battery Precautions

- ▶ If your product is equipped with a lithium battery, take the following precautions when replacing the battery.

### **CAUTION**

**Danger of explosion if the lithium battery is incorrectly replaced.**

- Replace only with the same or equivalent type recommended by the manufacturer
- Dispose of used batteries according to the manufacturer's instructions

# Table of Contents

Symbols .....	6
For Your Safety.....	7
High Voltage Safety Instructions .....	7
Special Handling and Unpacking Instruction .....	7
General Instructions on Usage.....	8
Environmental Protection Statement .....	8
Table of Contents .....	9
List of Tables.....	10
List of Figures .....	10
1/ Introduction.....	12
2/ Installation Procedures .....	13
2.1. Installing the Board .....	13
2.2. Chassis Safety Standards.....	14
3/ Product Variants.....	15
4/ Product Specification .....	16
4.1. Component Data.....	16
4.2. Standards and Certificates .....	18
4.3. Block Diagram .....	19
4.4. Supported Processors.....	20
4.4.1. Processor Cooling .....	21
4.5. System Memory Support.....	21
4.6. Graphics.....	22
4.7. Power Consumption .....	22
5/ Mainboard views .....	23
5.1. Top Side .....	23
5.2. External I/O Connector Side.....	24
5.3. Rear Side.....	25
6/ I/O Connectors .....	26
6.1. USB Connectors .....	26
6.2. Ethernet Connectors .....	27
6.3. Serial Port Connector (COM1).....	28
6.4. Display Port Connector .....	28
6.5. HDMI Connector .....	29
7/ Internal Connectors.....	30
7.1. USB Connectors .....	30
7.2. LVDS Connector.....	30
7.3. Internal Serial Port (COM2) .....	32
7.4. SATA Connector (SATA).....	32
7.5. SATA Internal Power(SATA_PWR1) .....	33
7.6. Audio Connector (AUDIO1) .....	33
7.7. Buzzer Connector (BZ1) .....	34
7.8. Front Panel (FP1).....	34
7.9. System Fan Connector (SYS_FAN1).....	34
7.10. Power Connector (J1).....	35
7.11. Mini PCIe Card socket 1 (MPCIE1/2) .....	36
7.12. Feature Connector (J2).....	37
7.13. CMOS Internal (CMOS1/2).....	38

8/	BIOS Settings.....	39
8.1.	Setup Menus.....	39
8.2.	Main Setup Menu.....	39
8.3.	Advanced Setup Menu.....	39
8.4.	Chipset Setup Menu.....	44
8.5.	Security Setup Menu.....	47
8.6.	Boot Setup Menu.....	47
8.7.	Save & Exit Setup Menu.....	48
9/	Technical Support.....	49
9.1.	Warranty.....	49
9.2.	Returning Defective Merchandise.....	50
	Appendix: List of Acronyms.....	51

## List of Tables

Table 1:	Standard operating temperature (0°C to +60°C).....	15
Table 2:	Industrial Temperature (-40°C to +85°C).....	15
Table 3:	Component Data.....	16
Table 4:	Standards and Certifications.....	18
Table 5:	Specification of Processor Variants.....	20
Table 6:	On-Board Graphics Output.....	22
Table 7:	Supply Voltage Requirements.....	22
Table 8:	Pin Assignment USB Connector.....	26
Table 9:	Pin Assignment Ethernet LAN connector (LAN1, LAN2).....	27
Table 10:	Pin Assignment Serial Connector.....	28
Table 11:	Display Port Connector.....	28
Table 12:	HDMI Connector.....	29
Table 13:	Pin Assignment USB1.....	30
Table 14:	Pin Assignment LVDS 40-Pin Connector.....	30
Table 15:	LVDS 40-Pin Connector Signals.....	31
Table 16:	Pin Assignment Serial Port Connector.....	32
Table 17:	Pin Assignment SATA Connector (SATA).....	32
Table 18:	Pin Assignment SATA Power (SATA_PWR).....	33
Table 19:	Pin Assignment Audio Connector (AUDIO1).....	33
Table 20:	Pin assignment Buzzer Connector (BZ1).....	34
Table 21:	Pin Assignment Front Panel Connector (FP1).....	34
Table 22:	Pin Assignment System Fan Connector (SYS_FAN1).....	35
Table 23:	Pin Assignment Internal 12 V ATX Power Connector.....	35
Table 24:	Mini PCIe Card.....	36
Table 25:	Feature Connector.....	37
Table 26:	CMOS1/CMOS2 Jumper.....	38
Table 27:	Main Setup Menu Sub-Screens Functions.....	39
Table 28:	Advanced Setup Menu Sub-Screens and Functions.....	39
Table 29:	Chipset Setup Menu Functions.....	44
Table 30:	Security Setup Menu Functions.....	47
Table 31:	Boot Priority Order.....	47
Table 32:	Save & Exit Setup Menu Functions.....	48
Table 33:	List of Acronyms.....	51

## List of Figures

Figure 1:	System Block Diagram.....	19
Figure 2:	3.5-SBC-APL with CPU Cooler.....	21
Figure 3:	Top Side View.....	23

Figure 4: I/O Connector Panel View ..... 24

Figure 5: Rear Side Board View ..... 25

Figure 6: Dual stack USB 3.0 Connector ..... 26

Figure 7: Ethernet LAN Connector (RJ45 Female)..... 27

Figure 8: Serial Connector ..... 28

Figure 9: Display Port Connector..... 28

Figure 10: HDMI Graphics Connector..... 29

Figure 11: USB 2.0 Connector (USB1)..... 30

Figure 12: LVDS 40-Pin Connector ..... 30

Figure 13: Serial Port Connector (COM2) ..... 32

Figure 14: SATA Connector ..... 32

Figure 15: SATA Power Internal Connector ..... 33

Figure 16: Audio Connector ..... 33

Figure 17: Buzzer connector (BZ1)..... 34

Figure 18: Front Panel Connector ..... 34

Figure 19: System Fan Connector ..... 34

Figure 20: Internal Power Connector (J1) ..... 35

Figure 21: 52-pin Mini PCIe Card ..... 36

Figure 22: 44-pin Feature Connector..... 37

Figure 23: CMOS1/CMOS2 Jumper ..... 38

# 1/ Introduction

This user guide describes the 3.5-SBC-APL motherboard from Kontron named as 3.5-SBC-APL within this user guide. The 3.5-SBC-APL is a 3.5" form factor, single board computer based on the Intel® Apollo Lake processor and features:

- ▶ Intel® Atom™ Mobile processor family with (2 MB Cache, from 2 GHz to 1.8 GHz), Apollo SoC (System-on-Chip)
- ▶ Intel® Mobile Celeron®N3350 processor with (2 MB cache, at 2.4 GHz) , TDP 6 W
- ▶ System memory up to 8 GB maximum
- ▶ 1x DDR3L SO-DIMM (1.35 V, 1867 MHz) non ECC memory
- ▶ 3x independent graphic displays: 1x DP, 1x HDMI and 1x LVDS
- ▶ 2x 10BASE-T/100BASE-TX/1000BASE-T Mbit Ethernet (IEEE802.3 conformity)
- ▶ 2x USB 3.0 on the external I/O connector panel and 1 x USB3.0 on the internal header
- ▶ 1x USB 2.0 and 1x USB3.0 on the front panel internal header
- ▶ 1x RS232/RS422/RS485 and 1 x RS232(internal)
- ▶ TPM2.0 and WIBU security features
- ▶ 2x PCIe mini

Use of this users guide implies a basic knowledge of PC-AT hardware and software. This user guide is focussed on describing the 3.5-SBC-APL motherboard's special features and is not intended to be a standard PC-AT textbook. The configuration and setup of the CPU board is either carried out automatically or manually by the user via the BIOS setup menus.

Before switching on the power, new users are recommended to study the short installation procedure in the following chapter Installation Procedures.

For the latest revision of this user guide, datasheet, thermal simulations, BIOS, drivers, BSP's (Board Support Packages), Mechanical drawings (2D and 3D), visit <http://www.kontron.com/>.

## 2/ Installation Procedures

### 2.1. Installing the Board



---

#### ESD Sensitive Device

Electrostatic discharge (ESD) can damage equipment and impair electrical circuitry.

- Wear ESD-protective clothing and shoes
  - Wear an ESD-preventive wrist strap attached to a good earth ground
  - Check the resistance value of the wrist strap periodically (OK: 1 MΩ to 10 MΩ)
  - Transport and store the board in an antistatic bag
  - Handle the board only at an approved ESD workstation
  - Handle the board only by the edges
- 

To get the board running follow the steps listed below. If the board shipped by KONTRON already has components such as a RAM and CPU cooler mounted, then skip the relevant step(s).

#### 1. Turn off the PSU (Power Supply Unit)

#### **NOTICE**

---

Turn off PSU (Power Supply Unit) completely (no mains power connected to the PSU) or leave the Power Connectors unconnected while configuring the board. Otherwise components (RAM, LAN cards etc.) might get damaged. Make sure to use a standard ATX PSU with a suitable cable kit and PS\_ON# active.

---

#### 2. Insert the memory module(s)

Be careful to push the memory module in the slot(s) before locking the tabs.

#### 3. Cooler Installation

The 3.5-SBC-APL comes with a pre-installed cooler.

#### 4. Connecting Interfaces

Insert all external cables for hard disk, keyboard etc. A monitor must be connected in order to change BIOS settings.

#### 5. Connect and turn on PSU

Connect PSU to the board by the ATX+12 V 4-pin connector.

#### 6. BIOS Setup

Enter the BIOS setup by pressing the <DEL> key during boot up. Enter "Exit Menu" and Load Setup Defaults. For BIOS setup information, see Chapter 8/ in this User Guide.



---

To clear all BIOS settings, including Password protection, activate "Load Default BIOS Settings" Clear CMOS Jumper for > 10 sec (without power connected).

---

#### 7. Mounting the board in chassis

#### **NOTICE**

---

When mounting the board to chassis etc. please note that the board contains components on both sides of the PCB that can easily be damaged if board is handled without reasonable care. A damaged component can result in malfunction or no function at all.

---

When fixing the Motherboard on a chassis it is recommended to use screws with integrated washer and a diameter of >7 mm. Do not use washers with teeth, as they can damage the PCB and cause short circuits.

## 2.2. Chassis Safety Standards

Take care when designing chassis interface connectors in order to fulfil the IEC60950-1 standard. 3.5-SBC-APL users must evaluate the end product to ensure compliance the requirements of the IEC60950-1 safety standard are met:

- ▶ The motherboard must be installed in a suitable mechanical, electrical and fire enclosure.
- ▶ The system in its enclosure must be evaluated for temperature and airflow considerations.
- ▶ The motherboard must be powered by a CSA or UL approved power supply that limits the maximum input current to 15 A via internal square ATX +12 V 4-pin connector.
- ▶ For interfaces having a power pin such as external power or fan, ensure that the connectors and wires are suitably rated. All connections from/to the product shall be with SELV circuits only.
- ▶ Wires have suitable rating to withstand the maximum available power.
- ▶ The enclosure of the peripheral device fulfils the fire protecting requirements of IEC60950-1.

---

**⚠ CAUTION**

**Danger of explosion if the lithium battery is incorrectly replaced.**

- ▶ Replace only with the same or equivalent type recommended by the manufacturer
  - ▶ Dispose of used batteries according to the manufacturer's instructions
-

### 3/ Product Variants

The 3.5-SBC-APL family of multicore SoC mobile processors is available in the following processor variants at the standard operating temperature and industrial temperature.

**Table 1: Standard operating temperature (0°C to +60°C)**

Product Number	Product Name	Description
43010-1000-14-1	3.5-SBC-APL N3350 C	3.5-SBC-APL Celeron N3350 2C 2.3GHz, 6W, with cooler

**Table 2: Industrial Temperature (-40°C to +85°C)**

Product Number	Product Name	Description
43011-0000-18-2	3.5-SBC-APL E2 E3930 E C	3.5-SBC-APL Atom E3930 2C 1.8GHz, 6,5W, E2, ECC, with cooler
43011-0000-18-4	3.5-SBC-APL E2 E3940 E C	3.5-SBC-APL Atom E3940 4C 1.8GHz, 9,5W, E2, ECC, with cooler
43011-0000-20-4	3.5-SBC-APL E2 E3950 E C	3.5-SBC-APL Atom E3950 4C 2.0GHz, 13W, E2, ECC, with cooler

## 4/ Product Specification

### 4.1. Component Data

The table below summarizes the features of the 3.5-SBC-APL embedded motherboard.

Table 3: Component Data

<b>Form Factor</b>	102 mm x 146 mm (3.5")	
<b>Processor</b>	Intel® Atom™ x7 E3950 4C 2.0 GHz, 12 W Intel® Atom™ x5 E3940 4C 1.8 GHz, 9.5W Intel® Atom™ x5 E3930 2C 1.8 GHz, 6.5 W Intel® Mobile Celeron® N3350 2C 2.3 GHz, 6 W	
<b>Memory</b>	DDR3L (1.35 V) 1867 MHz up to 8 GB, non ECC eMMC 64 GB	
<b>Embedded Controller</b>	1 x ITE IT8528E/FX (Kontron EC)	
<b>Graphics</b>	<b>Graphics Controller</b> Support for DirectX*11 OpenGL4.3, compliant of pixel shader OGL 3.2, Controller Intel Gen9LP	
	<b>DP to LVDS Controller</b> EDP to LVDS transceiver PTN3460BS/F6	
	<b>Display Interface</b> 1x DP version 1.2 1xHDMI 1.4b LVDS (40-pin Kontron LVDS)	
	<b>Display Pipes</b>	3
	<b>Max Resolution</b>	3840 x 2160 HDMI and DisplayPort
	<b>API</b>	Direct X12, OpenGL 4.3, OpenCL 2.0
	<b>Video Decoder</b>	H.264/AVC, MPEG-2, VC-1, JPEG/MJPEG, VP8, VP9, HEV 8, 10-bit
	<b>Video Encoder</b>	H.264/AVC, JPEG, MPEG-2, VP8, HEVC 8-bit
	<b>I/O Control</b>	
<b>Internal I/O</b>	<b>Power Mode</b> 1x 4-pin ATX power connector	
	<b>SATA</b> 1x SATA 3.0 (6 Gb/s)	
	<b>Internal power SATA</b> 5V and 12 V	
	<b>Serial IF (COM)</b> 1x RS232	
	<b>USB</b> 1x USB 2.0 (USB1) and 1x USB3.0 (USB3) on front panel internal header	
	<b>LVDS</b> 1x (40-pin), Kontron LVDS	

	<b>Fan</b> 1x fan pulse control
	<b>Front Panel</b> Power button, Reset button Power LED and Storage LED
	<b>GPIO</b> 1 x 18 dig I/O Kontron EC GPIO
	<b>Audio</b> 1 x audio, 1x buzzer
<b>External I/O</b>	<b>LAN</b> 2x 10/100/1000 Mbit Ethernet
	<b>USB</b> 2x USB 3.0
	<b>Display Port (DP)</b> 1 x DP version 1.2
	<b>HDMI</b> 1x HDMI
<b>Expansion Capabilities</b>	<b>miniPCle slot</b> 2x mPCle (1 x Half size (30 mm x 26,80 mm, 52-pins), 1 x Full size (30 mm x 50,95 mm, 52-pins))
<b>Hardware Status Monitor</b>	onboard & external Fan control, CPU Temp, Fan Speed, Input voltages Four voltages (Vcore, +12 V, +3.3 V, +5 V) Two temperatures ( CPU temperature, temperature at the center of the motherboard) fan speed
<b>Watchdog Timer</b>	Reset; 1 sec. to 255 min. and 1 sec. or 1 min./step
<b>Wake On</b>	Wake on LAN (WoL) S3 – S5, Wake on USB S3 – S5, Power Button (PwrBtn) S3 – S5
<b>Power Supply</b>	<b>Power Type</b> 12 V DC input (tolerance +/- 5%)
	<b>Power Connector</b> Internal 4-pin connector
<b>Battery</b>	BR2032, 195 mAh, 3 V
<b>BIOS</b>	BIOS AMI Aptio V UEFI
<b>Operating System Support</b>	Windows 10, Windows® 10 IoT, Windows 7, Linux 64 Bit, VXWorks
<b>Environmentals</b>	<b>Operating Temperature</b> 0°C to +60°C operating temperature (forced cooling) <b>Storage Temperature</b> -40°C to +70°C; lower limit of storage temperature <b>Humidity</b> 50% to 95% relative humidity (non-condensing) from 25°C to 30°C <b>Altitude/ Pressure</b> 2000 m maximum

## 4.2. Standards and Certificates

The 3.5-SBC-APL plans to be compliant to the following environmental conditions, and standards and certifications. It is the customer's responsibility to provide sufficient airflow around each of the components to keep them within allowed temperature range. Refer to the Thermal Simulation report, on Kontron's Web Page for more information about airflow.

Tests for the standards and certifications mentioned in the table below are current in progress.

**Table 4: Standards and Certifications**

<b>Electromagnetic Compatibility Standards (EMC)</b>	EN55032:2015/AC:2016, Class B EN55024:2014 + A1:2015 CISPR 32:2015 (Ed 2.0)/C1:2016 EN61000-3-2:2014 EN61000-3-3:2013
<b>Federal Communication Commission (FCC)</b>	FCC 47 CFR Part 15 Subpart B ANSI C63.4:2014 ISED ICES-003 (Issue 6)
<b>CE</b>	EMC Directive 2014/30/EU EN55032/EN55024
<b>Safety</b>	IEC 60950-1:2005 (Second Edition) + Am 1:2009 + Am 2:2013 and/or EN 60950-1:2006+A11:2009+A1:2010+A12:2011+A2:2013
<b>UL</b>	E147705-A98-UL UL 60950-1, 2nd Edition, 2014-10-14 (Information Technology Equipment - Safety - Part 1: General Requirements) CAN/CSA C22.2 No. 60950-1-07, 2nd Edition, 2014-10 (Information Technology Equipment - Safety - Part 1: General Requirements)
<b>Shock</b>	IEC 60068-2-27 – is planned Half sine wave, acceleration 2 g, pulse duration 11 ms, Number of shocks 600 ( 100 shocks for each face)
<b>Vibration</b>	IEC 60068-2-6 – is planned IAW IEC 60068-2-64, test Fh, Random vibration, 90 min. per axis, 3 axis at 1.9 grams, with PSD 10 hz-20 hz/0.05 g/Hz and 20 Hz-500 Hz/3 dB/octave
<b>Theoretical (MTBF)</b>	7 years according to Telcordia standard
<b>Restriction of Hazardous Substances (RoHS)</b>	2011/65/EU Compliant with the directive on the restriction of the use of certain hazardous substances in electrical and electronic equipment

### 4.3. Block Diagram

The following block diagram displays the system architecture of the 3.5-SBC-APL.

Figure 1: System Block Diagram

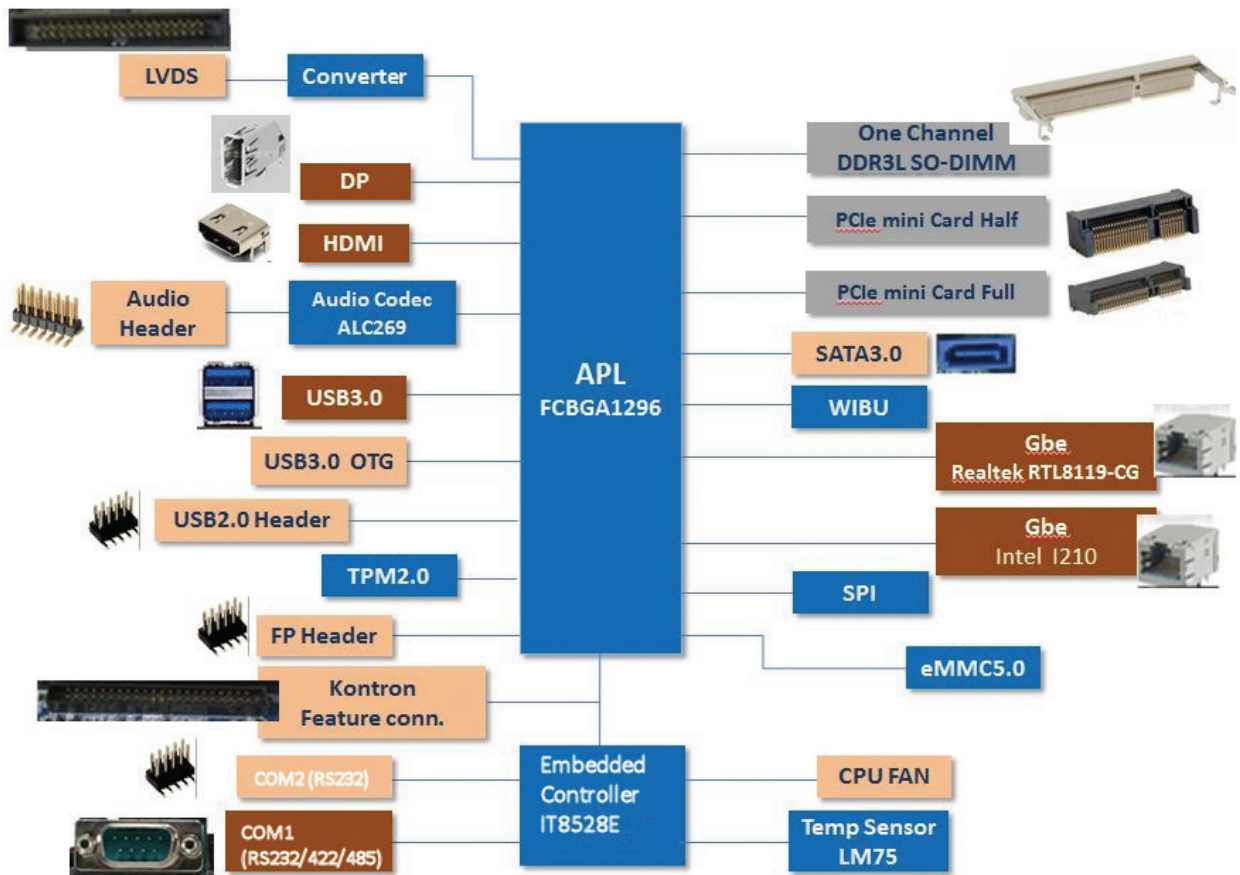

## 4.4. Supported Processors

The 3.5-SBC-APL supports the Atom processor family of multicore SoC mobile and the mobile version of the Intel Mobile Celeron N3350 2C.

- ▶ Intel® 64 Bit Architecture
- ▶ Intel® Virtualization Technology (VT-x) and Intel® directed I/O Virtualization Technology (VT-d)
- ▶ Enhanced Intel Speedstep® Technology
- ▶ Thermal Monitoring Technology
- ▶ Intel® HD Audio Technologies
- ▶ Intel® Identity Protection

**Table 5: Specification of Processor Variants**

Processor Variant	Atom™ x7 E3950 4C	Atom™ x5 E3940 4C	Atom™ x5 E3930 2C	Celeron N3350 2C
# of Cores	4	4	2	2
# of Threads	4	4	2	2
Processor Base Frequency	1.6 GHz	1.6 GHz	1.3 GHz	1.1 GHz
Burst Frequency	2 GHz	1.8 GHz	1.8 GHz	2.4 GHz
Thermal Design Power (TDP)/T <sub>JUNCTION</sub>	12 W/110°C	9.5 W/85°C	6.5 W/110°C	6 W/105°C
Memory Types	DDR3L-1866 MT/s	DDR3L-1866 MT/s	DDR3L-1866 MT/s	DDR3L-1866 MT/s
Maximum # Memory Channels	4	4	4	2
Max. Memory Size	8 GB	8 GB	8 GB	8 GB
Max. Memory Bandwidth	38.4 GB/s	34,1 GB/s	34,1 GB/s	
ECC Memory Supported	Yes	Yes	Yes	No
Graphics	HD Graphics 505	HD Graphic 500	HD Graphic 500	HD Graphic 500
PCIe Express Configurations	x4, x2, x1	x4, x2, x1	x4, x2, x1	1x4+1x2 or 4x1 or 2x1+1x2+1x2
Max. # PCIe Lanes	6	6	6	6

### 4.4.1. Processor Cooling

The 3.5-SBC-APL supports a combined cooling method with passive or active cooler to provide sufficient cooling to the processor and to remove the effects of TDP (Thermal Design Power). The level of sufficient cooling depends on the worst-case maximum ambient operating temperature and the actual worst-case load of processor. The chipset is cooled via passive cooling.

Figure 2: 3.5-SBC-APL with CPU Cooler

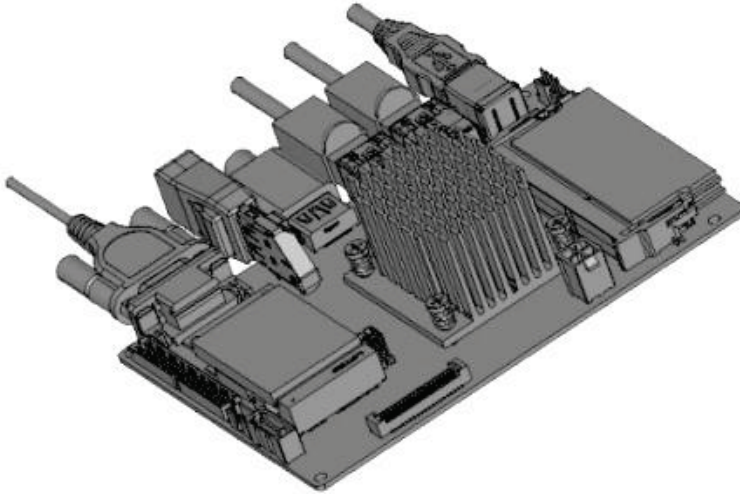

### 4.5. System Memory Support

The 3.5-SBC-APL has 1 GB of soldered down system memory and supports one DDR3L SO-DIMM socket. The sockets support the following memory features:

- ▶ DDR3L SO-DIMM 1.35 V (non ECC)
- ▶ 1x SO-DIMM DDR3L socket
- ▶ Maximum support memory up to 8 GB
- ▶ Memory controller speeds of 1867 MHz

The installed DDR SO-DIMM should support the Serial Presence Detect (SPD) data structure. This allows the BIOS to read and configure the memory controller for optimal performance.

## 4.6. Graphics

The 3.5-SBS-APL features on-board Intel® HD Graphics (Gen9LP) and supports three display pipes:

- ▶ DisplayPort (DP)
- ▶ HDMI
- ▶ LVDS

**Table 6: On-Board Graphics Output**

Processor	Graphics	Base Frequency	Graphic Output	Max. Resolution
Intel® Atom™ x7 E3950	Intel® HD graphics 505	500 MHz	HDMI DP	3840 x 2160 3840 x 2160
Intel® Atom™ x5 E3940 Intel® Atom™ x5 E3930	Intel® HD graphics 500	400 MHz	HDMI DP	3840 x 2160 3840 x 2160
Intel® Celeron® N3350	Intel® HD graphics 500	200 MHz	HDMI DP	3840 x 2160 3840 x 2160

## 4.7. Power Consumption

In order to ensure safe operation of the board, the input power supply must monitor the supply voltage and shut down if the supply is out of range, refer to the actual power supply specification. In order to keep the power consumption to a minimal level, boards do not implement a guaranteed minimum load. In some cases, this can lead to compatibility problems with ATX power supplies that require a minimum load to stay in regulation.

The 3.5-SBC-APL is powered by either a single 12 V DC Power Supply or optionally through an internal ATX 4-pin power connector using a standard ATX power supply.

### NOTICE

Hot Plugging with the power supply is not supported. Hot plugging might damage the board.

### NOTICE

ATX+12 V supply: ATX+12V 4-pin connector must be used in according to the ATX12V PSU standard.

**Table 7: Supply Voltage Requirements**

Supply	Min.	Max.	Note
+12 V	11.4 V	12.6 V	Supply voltage should be $\pm 5\%$ for compliance with the ATX specification
GND	0 V	0 V	Power Supply GND

### NOTICE

If any of the supply voltages drops below the allowed operating level longer than the specified hold-up time, all the supply voltages should be shut down and left OFF for a time long enough to allow the internal board voltages to discharge sufficiently.

If the OFF time is not observed, parts of the board or attached peripherals may work incorrectly or even suffer a reduction of MTBF.

The minimum OFF time depends on the implemented PSU model and other electrical factors and needs to be measured individually for each case.

## 5/ Mainboard views

### 5.1. Top Side

Figure 3: Top Side View

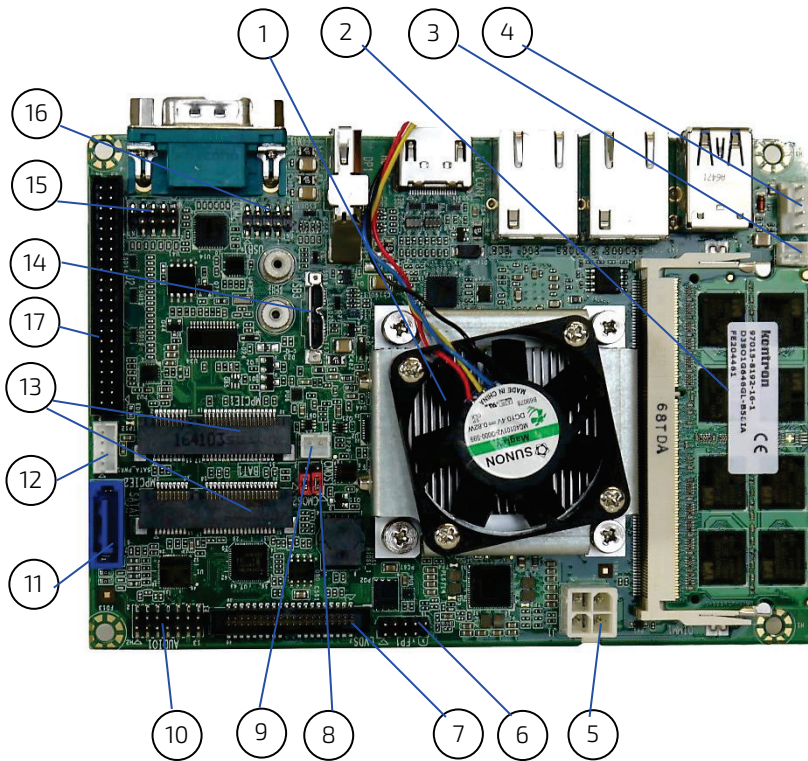

- 1 CPU with cooler
- 2 Memory
- 3 Buzzer connector
- 4 CPU fan connector
- 5 Power connector
- 6 Front panel
- 7 LVDS
- 8 CMOS Jumper
- 9 Battery connector
- 10 Audio
- 11 SATA
- 12 SATA Power
- 13 MPCle
- 14 USB 3.0 Micro B connector
- 15 COM2
- 16 USB 2.0
- 17 Feature Connector

## 5.2. External I/O Connector Side

Figure 4: I/O Connector Panel View

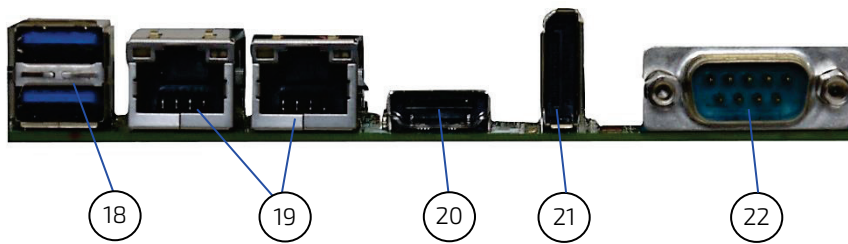

- 18 USB 3.0 connector
- 19 LAN connector
- 20 HDMI
- 21 Display Port
- 22 COM1 interface

### 5.3. Rear Side

Figure 5: Rear Side Board View

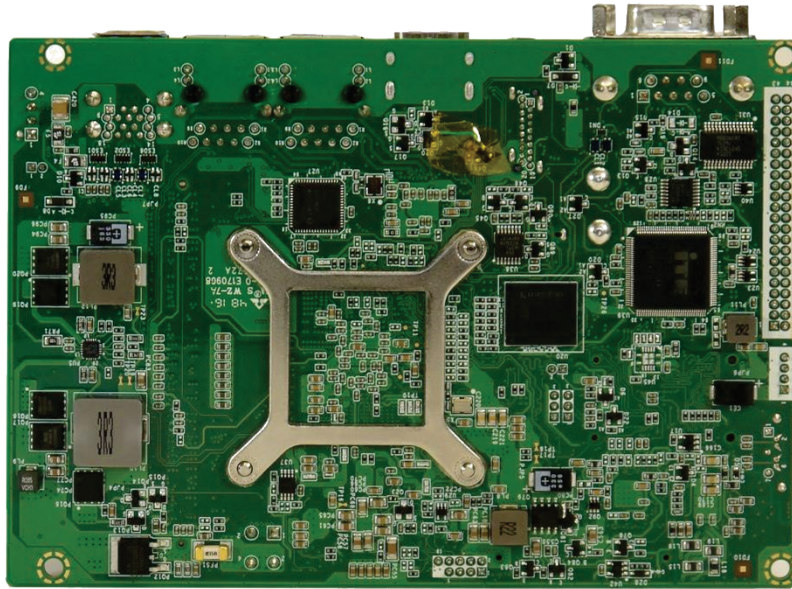

## 6/ I/O Connectors

### 6.1. USB Connectors

The USB 3.0 ports are available via a dual USB connector. USB3.0 ports are backward compatible with USB2.0

Figure 6: Dual stack USB 3.0 Connector

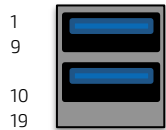

Table 8: Pin Assignment USB Connector

Pin	Signal
1	VBUS1
2	U_USB1N_R
3	U_USB1P_R
4	GND
5	USB3_L_RX1_N
6	USB3_L_RX1_P
7	GND
8	USB3_L_TX1_N
9	USB3_L_TX1_P
10	VBUS2
11	U_USB2N_R
12	U_USB2P_R
13	GND
14	USB3_L_RX2_N
15	USB3_L_RX2_P
16	GND
17	USB3_L_TX2_N
18	USB3_L_TX2_P
19	GND

## 6.2. Ethernet Connectors

The Ethernet LAN connectors (LAN1 and LAN2) provide two Ethernet ports with 10/100/1000 Mbit Ethernet data transfer rates. MDI means Media Dependent Interface.

Figure 7: Ethernet LAN Connector (RJ45 Female)

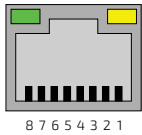

Table 9: Pin Assignment Ethernet LAN connector (LAN1, LAN2)

Pin	Signal
R1	L_MDIP0/LAN2_MDI_0
R2	L_MDIN0/LAN2_MDI_0J
R3	L_MDIP1/LAN2_MDI_1
R4	L_MDIN1/LAN2_MDI_1J
R5	LANxPW1/LANxPW2
R6	LANxPW1/LANxPW2
R7	L_MDIP2/LAN2_MDI_2
R8	L_MDIN2/LAN2_MDI_2J
R9	L_MDIP3/LAN2_MDI_3
R10	L_MDIN3/LAN2_MDI_3J
L1	LINK100/LAN2_LED_LINK100
L2	LINK1000/LAN2_LED_LINK1000
L3	LINKACT/LAN2_LED_LINKACT
L4	L_VDD33/LAN2_VDD33

### 6.3. Serial Port Connector (COM1)

The serial port connector (COM1) supports RS232/422/485.

Figure 8: Serial Connector

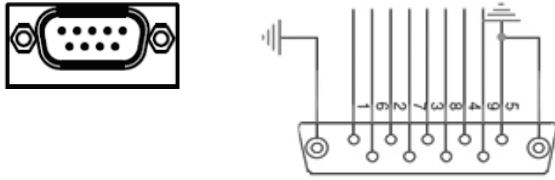

Table 10: Pin Assignment Serial Connector

Pin	Signal
1	NDCDA
2	NSINA
3	NSOUTA
4	NDTRA
5	GND
6	NDSRA
7	NRTSA
8	NCTSA
9	NRIA

### 6.4. Display Port Connector

The Display Port (DP) connector complies to the Display Port 1.2 standard.

Figure 9: Display Port Connector

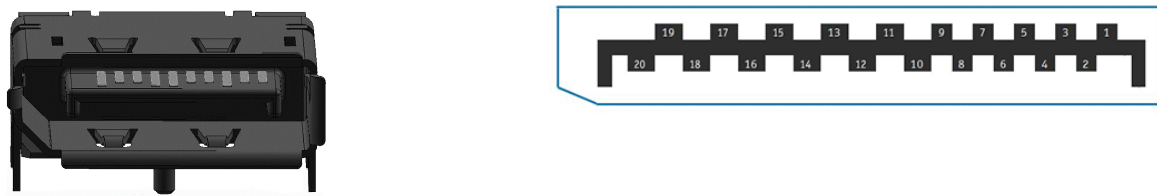

Table 11: Display Port Connector

Pin	Signal	Pin	Signal
1	DDIO_TX0_DP_R	2	GND
3	DDIO_TX0_DN_R	4	DDIO_TX1_DP_R
5	GND	6	DDIO_TX1_DN_R
7	DDIO_TX2_DP_R	8	GND
9	DDIO_TX2_DN_R	10	DDIO_TX3_DP_R
11	GND	12	DDIO_TX3_DN_R
13	DPO_DET	14	GND

Pin	Signal	Pin	Signal
15	DPD0_AUX_DP	16	GND
17	DPD0_AUX_DP	18	GND
19	GND	20	+3.3V

## 6.5. HDMI Connector

Figure 10: HDMI Graphics Connector

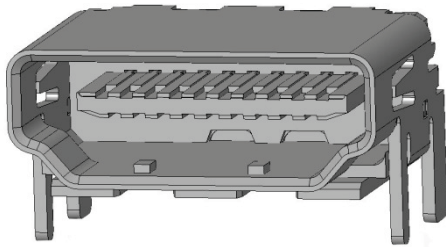

Table 12: HDMI Connector

Pin	Signal	Pin	Signal
1	DVITX2+	2	GND
3	DVITX2-	4	DVITX1+
5	GND	6	DVITX1-
7	DVITX0+	8	GND
9	DVITX0-	10	DVITXC+
11	GND	12	DVITXC-
13	x	14	x
15	HDMIxCLK	16	HDMIxDAT
17	GND	18	+5V
19	HPD_IN	20	

## 7/ Internal Connectors

### 7.1. USB Connectors

The following internal USB ports are available:

- ▶ 2x USB 2.0 on the front panel internal header (USB1)
- ▶ 1x micro USB 3.0, type B in the internal header
- ▶ 2x USB 3.0 on the external I/O panel

Figure 11: USB 2.0 Connector (USB1)

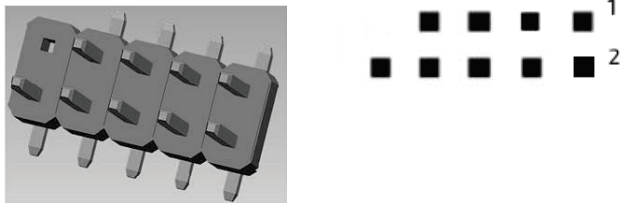

Table 13: Pin Assignment USB1

Pin	Signal	Pin	Signal
1	5VSB	2	5VSB
3	USB_P6_DN_R	4	USB_P7_DN_R
5	USB_P6_DP_R	6	USB_P7_DP_R
7	GND	8	GND
9		10	GND

### 7.2. LVDS Connector

The LVDS connector is based on a 40-pin connector and supports either single channel 18 bit/24 bit LVDS. The LVDS set up can be changed in the BIOS setup.

Figure 12: LVDS 40-Pin Connector

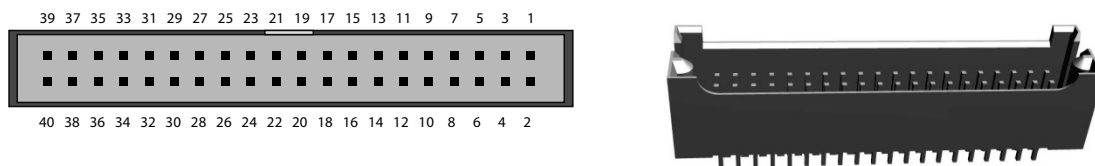

Table 14: Pin Assignment LVDS 40-Pin Connector

Pin	Signal	Type	Note
1	+12 V	PWR	Max. 0.5 A
2	+12 V	PWR	Max. 0.5 A
3	+12 V	PWR	Max. 0.5 A
4	+12 V	PWR	Max. 0.5 A
5	+12 V	PWR	Max. 0.5 A

Pin	Signal	Type	Note
6	GND	PWR	
7	+5 V	PWR	Max. 0.5 A
8	GND	PWR	
9	LCDVCC	PWR	Max. 0.5 A
10	LCDVCC	PWR	Max. 0.5 A
11	DDC CLK	OT	4.7 K $\Omega$ , 3.3 V
12	DDC DATA	OT	4.7 K $\Omega$ , 3.3 V
13	BKLTCTL	OT	3.3 V level
14	VDD ENABLE	OT	3.3 V level
15	BKLTEN#	OT	3.3 V level
16	GND	PWR	Max. 0.5 A
17	LVDS A0-	LVDS	
18	LVDS A0+	LVDS	
19	LVDS A1-	LVDS	
20	LVDS A1+	LVDS	
21	LVDS A2-	LVDS	
22	LVDS A2+	LVDS	
23	LVDS ACLK-	LVDS	
24	LVDS ACLK+	LVDS	
25	LVDS A3-	LVDS	
26	LVDS A3+	LVDS	
27	GND	PWR	Max. 0.5 A
28	GND	PWR	Max. 0.5 A
29	LVDS B0-	LVDS	
30	LVDS B0+	LVDS	
31	LVDS B1-	LVDS	
32	LVDS B1+	LVDS	
33	LVDS B2-	LVDS	
34	LVDS B2+	LVDS	
35	LVDS BCLK-	LVDS	
36	LVDS BCLK+	LVDS	
37	LVDS B3-	LVDS	
38	LVDS B3+	LVDS	
39	GND	PWR	Max. 0.5 A
40	GND	PWR	Max. 0.5 A

Table 15: LVDS 40-Pin Connector Signals

Signal	Description
LVDS A0...A3	LVDS A Channel data
LVDS ACLK	LVDS A Channel clock
LVDS B0...B3	LVDS B Channel data
LVDS BCLK	LVDS B Channel clock
BKLTCTL	Backlight control, PWM signal to implement voltage in the range 0 V-3.3 V
BKLTEN#	Backlight Enable signal (active low)
VDD ENABLE	Output display enable
LCDVCC	VCC supply to the display. 5 V or 3.3 V (1 A maximum) selected in BIOS setup menu. Power sequencing depends on LVDS panel selection.
DDC CLK	DDC Channel Clock
GND	Power Supply GND signal

### 7.3. Internal Serial Port (COM2)

The serial port connector COM2 supports one internal serial interface compliant with the RS232 standard.

Figure 13: Serial Port Connector (COM2)

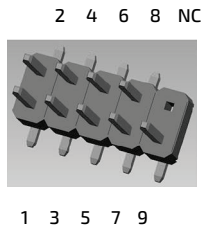

Table 16: Pin Assignment Serial Port Connector

Pin	Signal	Pin	Signal
1	NDCDB	2	NDSRB
3	NSINB	4	NRTSB
5	NSOUTB	6	NCTSB
7	NDTRB	8	NRIB
9	GND	10	

### 7.4. SATA Connector (SATA)

The SATA connector supplies a 3 Gbit/s data connection to the SATA hard disk and is SATA 2.0 compliant.

Figure 14: SATA Connector

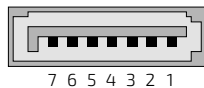

Table 17: Pin Assignment SATA Connector (SATA)

Pin	Signal
1	GND
2	SATA0TXP
3	SATA0TXN
4	GND
5	SATA0RXN
6	SATA0RXP
7	GND

## 7.5. SATA Internal Power(SATA\_PWR1)

The SATA power connector (SATA\_PWR1) supplies the SATA hard disk with either 12 V or 5 V.

Figure 15: SATA Power Internal Connector



Table 18: Pin Assignment SATA Power (SATA\_PWR)

Pin	Signal
1	+12V
2	GND
3	GND
4	VCC5

## 7.6. Audio Connector (AUDIO1)

The audio connector (AUDIO1) provides audio output, audio inputs and microphone signals.

Figure 16: Audio Connector

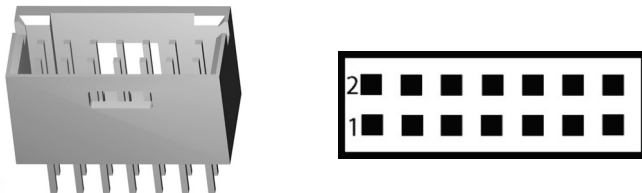

Table 19: Pin Assignment Audio Connector (AUDIO1)

Pin	Signal	Pin	Signal
1	A_MIC1_L	2	A_LOUT_L
3	GND	4	GND
5	A_MIC1_JD	6	A_LOUT_JD
7	A_MIC1_R	8	A_LOUT_R
9	GND	10	GND
11	SPK-L-C	12	SPK-R-C
13	SPK-L+C	14	SPK-R+C

## 7.7. Buzzer Connector (BZ1)

The buzzer connector (BZ1) provides an audio buzzer output signal.

Figure 17: Buzzer connector (BZ1)

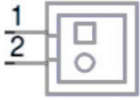

Table 20: Pin assignment Buzzer Connector (BZ1)

Pin	Signal
1	VCC5
2	SB_HDA_SPKR

## 7.8. Front Panel (FP1)

The front panel connector supplies signals for the power button, power LED and storage LED.

Figure 18: Front Panel Connector

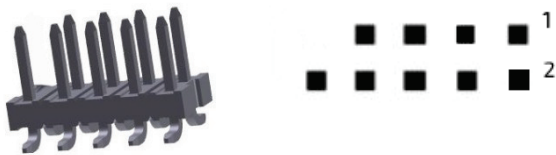

Table 21: Pin Assignment Front Panel Connector (FP1)

Pin	Signal	Pin	Signal
1	VCC3	2	GND
3	SB_SATA_LED#	4	3VSB
5	GND	6	SB_PWRBTN#
7	EXT_RESET#	8	GND
9		10	NC

## 7.9. System Fan Connector (SYS\_FAN1)

The system fan connector (SYS\_FAN1) is reserved for the system fan with PWM functions.

Figure 19: System Fan Connector

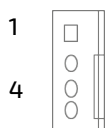

Table 22: Pin Assignment System Fan Connector (SYS\_FAN1)

Pin	Signal
1	SYS_FAN_CTRL
2	SYS_FAN_TACH
3	+12V
4	GND

## 7.10. Power Connector (J1)

The ATX 4-pin internal power supply connector is a standard motherboard power connector providing +12 V DC to the processor voltage regulator.

### **NOTICE**

Hot plugging of the power connectors is not allowed. Hot plugging might damage the board. When connecting to the motherboard, turn off main supply to make sure that all the power lines are turned off.



Figure 20: Internal Power Connector (J1)

Table 23: Pin Assignment Internal 12 V ATX Power Connector

Pin	Signal
1	GND
2	GND
3	DC12V
4	DC12V

## 7.11. Mini PCIe Card socket 1 (MPCIE1/2)

Figure 21: 52-pin Mini PCIe Card

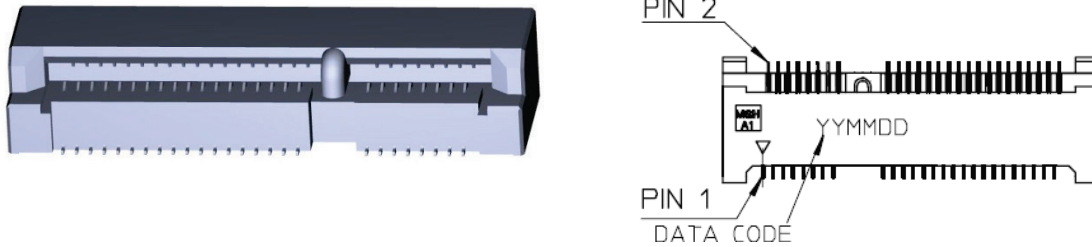

Table 24: Mini PCIe Card

Pin	Signal	Pin	Signal
1	WAKE#	2	+3.3V_S5
3	N.C.	4	GND
5	N.C.	6	+1.5V_S0
7	CLKREQ#	8	UIM-PWR
9	GND	10	UIM-DATA
11	PCIe_REFCLK-	12	UIM-CLK
13	PCIe_REFCLK+	14	UIM-RST
15	GND	16	UIM-VPP
17	UIM-C8	18	GND
19	UIM-C4	20	W_DISABLE#
21	GND	22	PLTRST#
23	PCIe_RX-	24	+3.3V_S5
25	PCIe_RX+	26	GND
27	GND	28	+1.5V_S0
29	GND	30	PU 3.3V(S5) (Optional: SMB_CLK)
31	PCIe_TX-	32	PU 3.3V(S5) (Optional: SMB_DAT)
33	PCIe_TX+	34	GND
35	GND	36	USB_D-
37	GND	38	USB_D+
39	+3.3V_S5	40	GND
41	+3.3V_S5	42	PU 3.3V(S0)
43	GND	44	PU 3.3V(S0)
45	N.C.	46	PU 3.3V(S0)
47	N.C.	48	+1.5V_S0
49	N.C.	50	GND
51	N.C.	52	+3.3V_S5

## 7.12. Feature Connector (J2)

Figure 22: 44-pin Feature Connector

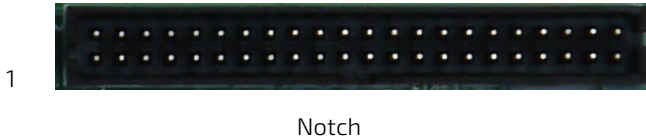

Table 25: Feature Connector

Pin	Signal	Pin	Signal
1	CASE_OPEN	2	SMBC
3	S5#	4	SMBD
5	PWR_OK	6	EXT_BAT
7	FAN3OUT	8	FAN3IN
9	SB3V3	10	SB5V
11	GPIO0	12	GPIO1
13	GPIO2	14	GPIO3
15	GPIO4	16	GPIO5
17	GPIO6	18	GPIO7
19	GND	20	GND
21	GPIO8	22	GPIO9
23	GPIO10	24	GPIO11
25	GPIO12	26	GPIO13
27	GPIO14	28	GPIO15
29	GPIO16	30	GPIO17
31	GND	32	GND
33	EGCLK	34	EGCS#
35	EGAD	36	TMA0
37	+12 V	38	GND
39	FAN4OUT	40	FAN4IN
41	GND	42	GND
43	GND	44	S3#

## 7.13. CMOS Internal (CMOS1/2)

Figure 23: CMOS1/CMOS2 Jumper

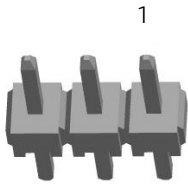

Table 26: CMOS1/CMOS2 Jumper

Pin	Description
1	3V_BATT
2	RTCRST#
3	GND



---

**Function:**

Pin 1-2: Default

Pin 2-3: Clear CMOS

---

## 8/ BIOS Settings

### 8.1. Setup Menus

The Setup utility features for menus listed in the selection bar at the top of the screen:

- ▶ Main
- ▶ Advanced
- ▶ Chipset
- ▶ Security
- ▶ Boot
- ▶ Save & Exit

The Setup menus are selected via the left and right arrow keys. The currently active menu and the currently active uEFI BIOS Setup item are highlighted in white. Each Setup menu provides two main frames. The left frame displays all available functions. Functions that can be configured are displayed in blue. Functions displayed in gray provide information about the status or the operational configuration. The right frame displays an Item Specific Help window providing an explanation of the respective function.

### 8.2. Main Setup Menu

Upon entering the uEFI BIOS Setup program, the Main Setup menu is displayed. This screen lists the Main Setup menu sub-screens and provides basic system information as well as functions for setting the system time and date.

**Table 27: Main Setup Menu Sub-Screens Functions**

Sub-Screen	Description
BIOS Information	Display BIOS Vendor, Core Version, and etc.
Board Information	Display Product Name, PCB ID, and etc.
CPU Information	Display Name, Type, Speed, and etc.
Memory Information	Display Total Memory and Memory Speed
Platform firmware Information	Display BXT, MRC, PUNIT, PMC, TXE and GOP
System Language	Set System Language
System Date	Set System Date
System Time	Set System Time

### 8.3. Advanced Setup Menu

The Advanced Setup menu provides sub-screens and functions for advanced configuration.

**Table 28: Advanced Setup Menu Sub-Screens and Functions**

Sub-Screen	Function	Description
Trusted Computing	Security Device Support	Enable/Disable BIOS support for security device
	SHA-1 PCR Bank	Enable/Disable SHA-1 PCR Bank
	SHA256 PCR Bank	Enable/Disable SHA256 PCR Bank
	TPM State	Enable/Disable security device

Sub-Screen	Function	Description	
	Pending Operation	Schedule an Operation for the Security Device	
	Platform Hierarchy	Enable/Disable Platform Hierarchy	
	Storage Hierarchy	Enable/Disable Storage Hierarchy	
	Endorsement Hierarchy	Enable/Disable Endorsement Hierarchy	
	TPM2.0 UEFI Spec Version	Select the TCG2 Spec Version Support, TCG_1_2: the compatible mode for win8/win10 TCG_2: Support new TCG2 protocol and event format for win10 or later	
	Physical Presence Spec Version	Select to Tell O.S to support PPI Spec Version 1.2 or 1.3. Note some HCK tests might not support 1.3	
	Device Select	TPM 1.2 will restrict support to TPM 1.2 device, TPM 2.0 will restrict support to TPM 2.0 device, Auto will support both with the default set to TPM 2.0 devices if not found, TPM 1.2 will be enumerated	
ACPI Settings	Enable ACPI Auto Configuration	Enable/Disable BIOS ACPI Auto Configuration	
	Enable Hibernation	Enable/Disable system ability to Hibernate (OS/S4 Sleep state). This option may be not effective with some OS	
	ACPI Sleep State	Select the Highest ACPI Sleep state the system will enter when the SUSPEND button is pressed	
	LOCK Legacy resources	Enable/Disable Lock of Legacy Resources	
SMART Settings	SMART Self Test	Run SMART Self Test on all HDDs during POST	
IT8528 Super IO Configuration	Serial Port 1 Configuration	Serial Port	Enable/Disable Serial Port (COM)
		Device Settings	Display Device Settings
		Change Settings	Select an optimal settings for Super IO Device
		Mode	Sets RS485 full mode, RS485 half duplex mode or RS232
		Termination Control	Select COM1 receiver termination
	Serial Port 2 Configuration	Serial Port	Enable/Disable Serial Port (COM)
		Device Settings	Display Device Settings
		Change Settings	Select an optimal settings for Super IO Device

Sub-Screen	Function		Description
Serial Port Console Redirection	Legacy Console Redirection Settings	Legacy Serial Redirection Port	Select a COM port to display redirection of Legacy OS and Legacy OPROM Messages
	Console Redirection		Enable/Disable Console Redirection
	Console Redirection Settings	Terminal Type	Emulation: ANSI: Extended ASCII char set. VT100: ASCII char set. VT100+: Extends VT100 to support color, function keys, etc. VT-UTF8: Uses UTF8 encoding to map Unicode
		Bits per second	Select serial port transmission speed
		Flow Control	Flow control can prevent data loss from buffer overflow
		Data Bits	Data Bits
		Parity	A parity bit can be sent with the data bit to detect some transmission errors
		Stop Bits	Stops bits indicate the end of a serial data packet
CPU Configuration	Turbo Mode		Enable/Disable Turbo Mode
	Intel Virtualization Technology		When Enabled, a VMM can Utilize the additional hardware capabilities provided by Vanderpool Technology
	VT-d		Enable/Disable CPU VT-d
	Bi-directional PROCHOT		When a processor thermal sensor trips (either core), the PROCHOT# will be driven. If bi-directional is enabled, external agents can drive PROCHOT# to throttle the processor
	Monitor Mwait		Enable/Disable Monitor Mwait
	Network Stack Configuration	Network Stack	
CSM Configuration	CSM Support		Enable/Disable Compatibility Support Module
NVMe Configuration	NVMe controller and Device information		No NVMe Device Found
USB Configuration	Legacy USB Support		Enables Legacy USB support
	XHCI Hand-off		This is a workaround for OSES without XHCI hand-off support
	USB Mass Storage Driver Support		Enable/Disable USB Mass Storage Driver Support
	USB transfer time-out		The time-out value for Control, Bulk, and Interrupt transfer
	Device reset time-out		USB mass storage device start unit

Sub-Screen	Function	Description
		command time-out
	Device power-up delay	Maximum time for the device will take before it properly report itself to the Host Controller
Platform Trust Technology	fTPM	Enable/Disable fTPM
Security Configuration	TXE HMRFP0	Enable/Disable TXE HMRFP0
	TXE EOP Message	Enable/Disable EOP Message
LVDS Configuration	LVDS Flat Panel Display Support	Enable/Disable LVDS Flat Panel Display Support
	Panel Type	Select the type or Manufacturer's name of the display panel
	Resolution	Select the screen resolution of the display panel
	Panel Color Depth	Select the display panel color depth
	Panel Voltage	Select the voltage level for powering the LVDS Display Panel
	Channel	Select LVDS Interface Signals mode Single-Channel or Dual-Channel (Sometimes called "Single-Pixel" or "Dual-Pixel")
	Bus Swapping	Swap LVDS interface signals: Normal – use bus as indicated by pin name, Swapped – swap odd bus signals with even bus signals
	Clock Frequency Center Spread	Programmable center spreading of pixel clock frequency to minimize EMI
	Differential Output Swing Level	Programmable LVDS signal swing to pre-compensate for channel attenuation or allow for power saving
	Backlight	Enable/Disable Backlight
	Backlight Signal Inversion	Enable – Active High Disable – Active Low for display panel Backlight signal
	Backlight PWM Frequency	Set the PWM frequency the backlight
	Brightness Level	Select the Brightness Level for the backlight of the display panel
	System Temperature	Display the System Temperature
	System Temperature Offset	Adjust the offset value in C (Two's Complement)
	CPU Temperature	Display CPU Temperature

Sub-Screen	Function	Description
Hardware Health Configuration	System Fan Speed	Display System Fan Speed
	Fan Cruise Control	Disable = Full speed Thermal = does regulate fan speed according to specified temperature Speed = does regulate according to specified speed
	Watchdog Function	0 = Disable. Enter the service interval in seconds before the system will reset
	ITE8528 Firmware Update	This option is enable Auto Update when version is not match, force update or disable update EC firmware
	PC Speaker/Beep	Control the default beeps during boot of the system
Thermal	Automatic Thermal Reporting	Configure _CRT, _PSV, _ACO automatically based on values recommended in BWG's Thermal Reporting for Thermal Management settings. Set to Disabled for manual configuration.
	Critical Trip Point	This value controls the temperature of the ACPI Critical Trip Point – the point in which the OS will shut the system off
	Passive Trip point	This value controls the temperature of the ACPI Passive Trip Point – the point in which the OS will begin throttling the processor
	Active Trip Point	This value controls the temperature of the ACPI Active Trip Point – the point in which the OS will turn the fan on
	DPTF	Enable/Disable DPTF
System Component	OS Reset Select	Select the reset type in FACP table
	DDR SSC	Enable DDR Spread Spectrum Clocking configuration
	DDR SSC Selecting Table	Choose the item in SSC selection table for DDR spread spectrum
	DDR Clock Bending Selection Table	Choose for clock bending
	HighSpeed SerialIO SSC	Enable HighSpeed SerialIO Spread Spectrum Clocking configuration
	HighSpeed SerialIO SSC Selection T	Choose the item in SSC selection table for HighSpeed Serial IO spread spectrum
RC ACPI Settings	Native PCIE Enable	Enable/Disable Native PCIE Enable
	Native ASPM	Auto/Enable/Disable Controlled ASPM
RTD3 settings	RTD3 Support	Enable/Disable Runtime D3 support

## 8.4. Chipset Setup Menu

The Chipset Setup menu provides information about the configuration.

**Table 29: Chipset Setup Menu Functions**

Sub-Screen	Function	Description
North Bridge	Max Top of Low Usable DRAM (Dynamic Random Access Memory) (TOLUD)	Maximum value of TOLUD
	Above 4GB MemoryMappedIO (MMIO) BIOS assignment	Enable/Disable above 4GB MemoryMappedIO BIOS assignment
	PCIE VGA Workaround	Enable if your PCIe card cannot boot to DOS
South Bridge	Serial IRQ Mode	Configure Serial IRQ Mode
	SMBus Support	Enabled/Disabled SMBus Support
	OS selection	Select the Target OS
	PCI CLOCK RUN	Enables CLKRUN# logic to stop PCI clocks
	Real Time Option	Select Read-Time Enabled and IDI Agent Real-Time Traffic Mask Bits
Uncore Configuration	GOP Driver	Enable GOP driver will unload VBIOS; Disable it will load VBIOS
	Intel Graphics Pre-EFI Initialization (PEI) Display Peim	Enable/Disable Pei (Early) Display
	GOP Brightness Level	Set GOP Brightness Level; Value ranges from 0-255
	Integrated Graphics Device	Enable : Enabled IGD when selected as the primary Video Adapter. Disable : Always disable IGD
	Primary Display	Select which of IGD/PCI Graphics device should be Primary Display
	RC6(Render Standby)	Check to enable render standby support, RC6 should be enabled if S0ix is enabled. This item will be read only if S0ix is enabled.
	GTT Size	Select the GTT Size
	Aperture Size	Select the Aperture Size
	DVMT Pre-Allocated	Select DVMT 5.0 Pre-Allocated (Fixed) Graphics Memory size used by the

Sub-Screen	Function		Description
			Internal Graphics Device
	DVMT Total Gfx Mem		Select DVMT 5.0 Total Graphics Memory size used by the Internal Graphics Device
	Cd Clock Frequency		Select the highest Cd Clock frequency supported by the platform
	GT PM Support		Enable/Disable GT PM Support
	PAVP Enabled		Enable/Disable PAVP
	BIA		Auto: GMCH Use VBIOS; Default; Level n: Enabled with selected Aggressiveness Level
	ALS Support		Valid only for ACPI
	IGD Flat Panel		Select IGD Flat panel Resolution
	IGD Boot Type		Select preference for IGD display interface used when system boots.
	Panel Scaling		Select Panel scaling
	GMCH BLC Control		Back Light Control Setting
South Cluster Configuration	HD-Audio Configuration	HD-Audio Support	Enable/Disable HD-Audio Support
	PCI-Express Configuration	PCI Express Clock Gating	PCI Express Clock Gating Enable/Disable for each root port
		Port 8xh Decode	PCI express Port8xh Decode Enable/Disable
		Peer Memory Write Enable	Peer Memory Write Enable/Disable
		Compliance Mode	Compliance Mode Enable/Disable
		PCIe #0 BDF [00:13:00] LAN1 (Intel I210)	Control the PCI Express Root port PCIe #0
		PCIe #1 BDF [00:13:01] LAN1 (RealTek 8119)	Control the PCI Express Root port PCIe #1
		PCIe #2 BDF [00:13:02] mPCIe 1	Control the PCI Express Root port PCIe #2
		PCIe #3 BDF [00:13:03] mPCIe 3	Control the PCI Express Root port PCIe #3
	SATA Drives	Port 0	Enable/Disable SATA Port

Sub-Screen	Function	Description	
	SCC Configuration	SCC eMMC Support	Enable/Disable SCC eMMC Support
		eMMC Max Speed	Select the eMMC max Speed allowed
	USB Configuration	XHCI Pre-Boot Driver	Enable/Disable XHCI Pre-Boot Driver support
		USB VBUS	VBUS should be ON in HOZST mode. It should be OFF in OTG device mode
		USB HSIC1 Support	Enable/Disable USB HSIC1
		USB SSIC1 Support	Enable/Disable USB SSIC1
		USB Port Disable Override	Selectively Enable/Disable the corresponding USB port from reporting a Device Connection to the controller
		XDCI Support	Enable/Disable XDCI
		XHCI Disable Compliance Mode	Options to disable XHCI Link Compliance mode. Default is FALSE to not disable Compliance Mode. Set TRUE to disable Compliance Mode
	Miscellaneous Configuration	High Precision Timer	Enable/Disable the High Precision Event Timer
		State After G3	Specify what state to go to when power is re-applied after a power failure (G3 state).
		Power Button Debounce Mode	Enable interrupt when PWRBTN# is asserted.
		Wake On Lan	Enable/Disable the Wake on Lan
		BIOS Lock	Enable/Disable the SC BIOS Lock Enable feature. Required to be enabled to ensure SMM protection of flash.
		RTC Lock	Enable will lock bytes 38h-3Fh in the lower/upper 128-byte bank of RTC RAM
TCO Lock		Enable TCO and Lock Down TCO	
DCI enable (HDCIEN)		When DCI enable, it is taken as user consent to enable the DCI which allows debug over the USB3 interface.	

Sub-Screen	Function	Description
		When Disabled, the host control is not enabling DCI feature.
	GPIO Lock	Enable to set GPIO Pad Configuration Lock for security.

## 8.5. Security Setup Menu

The Security Setup menu provides information about the passwords and functions for specifying the security settings. The passwords are case-sensitive.

**Table 30: Security Setup Menu Functions**

Function	Description	
Administrator Password	Set Setup Administrator Password	
User Password	Set user password	
Secure Boot	Attempt Secure Boot	Secure Boot Activated when Platform Keys (PK) is enrolled, system mode is user/deployed, and CSM function is disable
	Enter Audit Mode	Enter Audit Mode. If current System Mode is User – PK variable will be erased on transition to Audit
	Secure Boot Mode	Secure Boot Mode – Custom & Standard, Set UEFI Secure Boot Mode to STANDARD mode or CUSTOM mode, this change is effect after save. And after reset, the mode will return to STANDARD mode
	Key Management	Enables expert users to modify Secure Boot Policy variables without full authentication

## 8.6. Boot Setup Menu

The Boot Setup menu lists the for boot device priority order, which is dynamically generated.

**Table 31: Boot Priority Order**

Function	Description
Setup Prompt Timeout	Number of seconds to wait for setup activation key
Bootup NumLock State	Select the keyboard NumLock state
Quiet Boot	Enables/Disables Quiet Boot option
Boot Option #1	Sets the system boot order
Fast Boot	Enables or Disable fast Boot features. Most probes are skipped to reduce

Function	Description
	time during boot.
SATA Support	Select Last Boot HDD only or All Sata Devices
VGA Support	If Auto, only install Legacy OpRom with Legacy OS and logo would NOT be shown during post. Efi driver will still be installed with EFI OS.
USB Support	If disabled, all USB devices will NOT be available until after OS boot. If Partial Initial, USB Mass Storage and specific USB port/device will NOT be available before OS boot. If Enabled, all USB devices will be available in OS and Post.
PS2 Devices Support	If disabled, PS2 devices will be skipped
Network Stack Driver Support	If disabled, Network Stack Driver will be skipped
Redirection Support	If disabled, Redirection function will be disabled
New Boot Option Policy	Controls the placement of newly detected UEFI boot options

## 8.7. Save & Exit Setup Menu

The Save & Exit Setup menu provides functions for handling changes made to the UEFI BIOS settings and the exiting of the Setup program.

**Table 32: Save & Exit Setup Menu Functions**

Function	Description
Save Changes and Exit	Exit system setup after saving the changes
Discard Changes and Exit	Exit system setup without saving any changes
Save Changes and Reset	Reset the system after saving the changes
Discard Changes and Reset	Reset system setup without saving any changes
Save Changes	Save changes done so far to any of the setup option
Discard Changes	Discard changes done so far to any of the setup option
Restore Defaults	Restore/Load Default values for all the setup option
Save as User Defaults	Save the changes done so far as User Defaults
Restore User Default	Restore the User defaults to all the setup option
UEFI: Built-in EFI Shell	Go to UEFI shell
Launch EFI Shell from filesystem device	Attempts to Launch EFI Shell application (Shell.efi) from one of the available filesystem devices

## 9/ Technical Support

For technical support contact our Support department:

- ▶ E-mail: support@kontron.com
- ▶ Phone: +49-821-4086-888

Make sure you have the following information available when you call:

- ▶ Product ID Number (PN),
- ▶ Serial Number (SN)



---

**The serial number can be found on the Type Label, located on the product's rear side.**

---

Be ready to explain the nature of your problem to the service technician.

### 9.1. Warranty

Due to their limited service life, parts that by their nature are subject to a particularly high degree of wear (wearing parts) are excluded from the warranty beyond that provided by law. This applies to the CMOS battery, for example.



---

**If there is a protection label on your product, then the warranty is lost if the product is opened.**

---

## 9.2. Returning Defective Merchandise

All equipment returned to Kontron must have a Return of Material Authorization (RMA) number assigned exclusively by Kontron. Kontron cannot be held responsible for any loss or damage caused to the equipment received without an RMA number. The buyer accepts responsibility for all freight charges for the return of goods to Kontron's designated facility. Kontron will pay the return freight charges back to the buyer's location in the event that the equipment is repaired or replaced within the stipulated warranty period. Follow these steps before returning any product to Kontron.

1. Visit the RMA Information website:  
<http://www.kontron.com/support-and-services/support/rma-information>

Download the RMA Request sheet for **Kontron Europe GmbH** and fill out the form. Take care to include a short detailed description of the observed problem or failure and to include the product identification Information (Name of product, Product number and Serial number). If a delivery includes more than one product, fill out the above information in the RMA Request form for each product.

2. Send the completed RMA-Request form to the fax or email address given below at Kontron Europe GmbH. Kontron will provide an RMA-Number.

Kontron Europe GmbH  
RMA Support  
Phone: +49 (0) 821 4086-0  
Fax: +49 (0) 821 4086 111  
Email: [service@kontron.com](mailto:service@kontron.com)

3. The goods for repair must be packed properly for shipping, considering shock and ESD protection.



---

**Goods returned to Kontron Europe GmbH in non-proper packaging will be considered as customer caused faults and cannot be accepted as warranty repairs.**

---

4. Include the RMA-Number with the shipping paperwork and send the product to the delivery address provided in the RMA form or received from Kontron RMA Support.

## APPENDIX: LIST OF ACRONYMS

Table 33: List of Acronyms

<b>BMC</b>	Base Management Controller
<b>CLI</b>	Command-Line Interface
<b>COM</b>	Computer-on-Module
<b>ECC</b>	Error Checking and Correction
<b>FCC</b>	Federal Communication Commission
<b>FRU</b>	Field Replaceable Unit
<b>GPIO</b>	General Purpose Input Output
<b>GPU</b>	Graphics Processing Unit
<b>HDAC</b>	High Definition Audio Codec
<b>IOL</b>	IPMI-Over-LAN
<b>IOT</b>	Internet of Things
<b>IPMI</b>	Intelligent Platform Management Interface
<b>KCS</b>	Keyboard Controller Style
<b>KVM</b>	Keyboard Video Mouse
<b>LVDS</b>	Low Voltage Differential Signaling
<b>MEI</b>	Management Engine Interface
<b>MMIO</b>	MemoryMappedIO
<b>MTBF</b>	Mean Time Before Failure
<b>NCSI</b>	Network Communications Services Interface
<b>PCIe</b>	PCI-Express
<b>PECI</b>	Platform Environment Control Interface
<b>RTC</b>	Real Time Clock
<b>SATA</b>	Serial Advanced Technology Attachment
<b>SEL</b>	System Event Log
<b>ShMC</b>	Shelf Management Controller
<b>SMBus</b>	System Management Bus
<b>SMWI</b>	System Monitor Web Interface
<b>SoC</b>	System-on-Chip
<b>SOL</b>	Serial Over LAN
<b>SSD</b>	Solid State Drive
<b>SSH</b>	Secure Shell
<b>TDP</b>	Thermal Design Power
<b>TOLUD</b>	Top of Low Usable DRAM (Dynamic Random Access Memory)
<b>TPM</b>	Trusted Platform Module
<b>UEFI</b>	Unified Extensible Firmware Interface
<b>VLP</b>	Very Low Profile
<b>WEC</b>	Windows Embedded Compact software

## About Kontron

Kontron is a global leader in IoT/Embedded Computing Technology (ECT). As a part of technology group S&T, Kontron, together with its sister company S&T Technologies, offers a combined portfolio of secure hardware, middleware and services for Internet of Things (IoT) and Industry 4.0 applications. With its standard products and tailor-made solutions based on highly reliable state-of-the-art embedded technologies, Kontron provides secure and innovative applications for a variety of industries. As a result, customers benefit from accelerated time-to-market, reduced total cost of ownership, product longevity and the best fully integrated applications overall.

For more information, please visit: <http://www.kontron.com/>



### HEADQUARTERS

#### **KONTRON S&T AG**

Lise-Meitner-Str. 3-5  
86156 Augsburg  
Germany  
Tel.: +49 821 4086-0  
Fax: +49 821 4086-111  
[info@kontron.com](mailto:info@kontron.com)