



Latest Generation Intel Atom® , Pentium® and Celeron® Processor Series

- ▶ Up to 16 GByte LPDDR5 memory down with inband ECC support
- ▶ Dual LVDS, HDMI, DP++
- ▶ 1x USB 3.2, 6x USB 2.0, eMMC onboard
- ▶ Industrial grade temperature

COMPLIANCE	SMARC™ module 2.1.1
DIMENSIONS (H X W X D)	82 x 50 mm
CPU	Intel Amston Lake SKUs – Industrial RE-Series
CHIPSET	-
MAIN MEMORY	Up to 16 GByte LPDDR5 memory down with inband ECC support
GRAPHICS CONTROLLER	Gen 12 IGFX
ETHERNET	Up to 2.5GbE
STORAGE	1x SATA 6Gb/s
FLASH ONBOARD	up to 128 GByte eMMC (MLC)
PCI EXPRESS®	up to 4x PCIe x1
PANEL SIGNAL	1x HDMI (on request DP++), 1x DP++, 1x Dual LVDS (on request eDP)
USB	1x USB 3.2, 6x USB 2.0
SERIAL	4x UART (2x RX/TX only)
OTHERS FEATURES	HD Audio, I ² C, 2x SPI, 14x GPIOs
SPECIAL FEATURES	Trusted Platform Module TPM 2.0 Industrial Temperature Grade versions
FEATURES ON REQUEST	eMMC: up to 64 GByte pSLC RAM: from 2 GByte to 16 GByte LPDDR4
BIOS	AMI UEFI
OPERATING SYSTEM	Windows® 10 (IoT) Enterprise x64, Windows® 11, Linux
POWER SUPPLY	5V only! No Widerange
TEMPERATURE	Industrial grade: -40 °C to +85 °C operating, -40 °C to +85 °C non-operating
HUMIDITY	93 % relative Humidity at 40 °C, non-condensing (according to IEC 60068-2-78)

Block Diagram

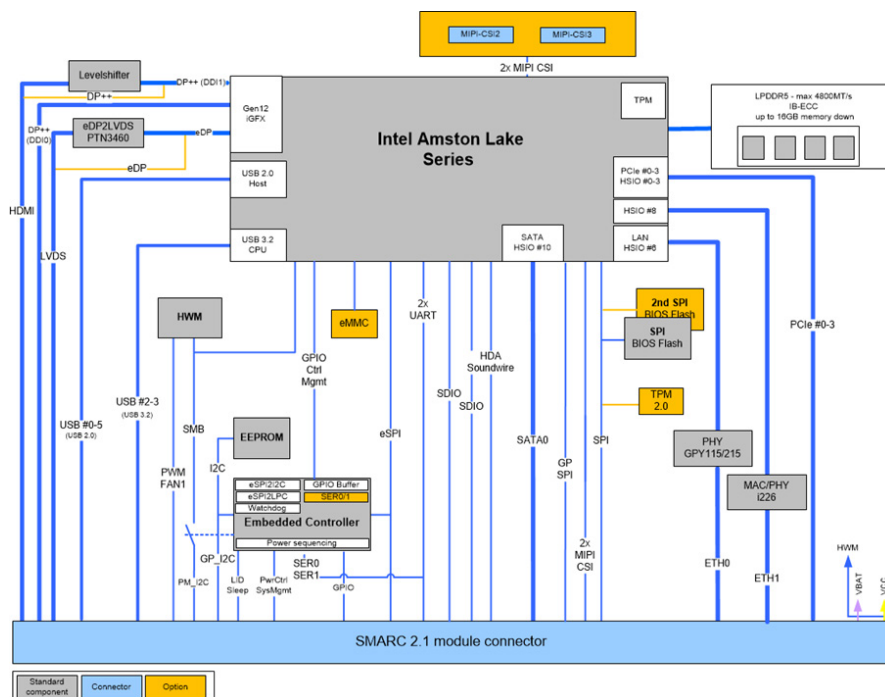

ARTICLE	PART NO.	DESCRIPTION
SMARC-sXAS E2 x7211RE 4G/32G	51018-0432-R1-2	SMARC™ with Intel Atom® x7211RE, 2 core, 1.0GHz, 4GB LPDDR5 memory down, 32GB eMMC TLC, industrial temperature
SMARC-sXAS E2 x7213RE 4G/32G	51018-0432-R2-2	SMARC™ with Intel Atom® x7213RE, 2 core, 2.0GHz, 4GB LPDDR5 memory down, 32GB eMMC TLC, industrial temperature
SMARC-sXAS E2 x7433RE 4G/32G	51018-0432-R2-4	SMARC™ with Intel Atom® x7433RE, 4 core, 1.5GHz, 4GB LPDDR5 memory down, 32GB eMMC TLC, industrial temperature
SMARC-sXAS E2 x7835RE 8G/32G	51018-0832-R2-8	SMARC™ with Intel Atom® x7835RE, 8 core, 1.3GHz, 8GB LPDDR5 memory down, 32GB eMMC TLC, industrial temperature

Carrier

ARTICLE	PART NO.	DESCRIPTION
SMARC™ Evaluation Carrier 2.1	51301-0000-00-0	SMARC™ Evaluation Carrier for SMARC™ modules according to the SMARC™ 2.1 standard (without SMARC™ module)

Cooling

ARTICLE	PART NO.	DESCRIPTION
HSP SMARC-sXAS	51018-0000-99-1	Heatspreader for SMARC-sXAS

Global Headquarters

Kontron Europe GmbH

Gutenbergstraße 2
85737 Ismaning, Germany
Tel.: + 49 821 4086-0
info@kontron.com

www.kontron.com